



COMMISSION MEETING MINUTES
January 27, 2026

- | <u>No.</u> | <u>Topic</u> |
|------------|--|
| | Call to Order |
| 1. | <u>Awards and Recognition</u> |
| 2. | <u>Public Comments Not Related to the Agenda</u> |
| 3. | <u>Consent Agenda</u> |
| 4. | <u>Report of the Study of the Estimated Economic Impact of HRSD and Sustainable Water Initiative for Tomorrow (SWIFT) Briefing</u> |
| 5. | <u>Kempsville Interceptor Force Main Replacement – Phase I Initial Appropriation – Non-Regulatory and Contract Award (>\$200,000)</u> |
| 6. | <u>CREW Carbon, Inc. Agreements for VIP and Army Base Treatment Plants</u> |
| 7. | <u>calDENSE Calcium Carbonate (CaCO₃) Technology and Equipment Contract Award (>\$200,000)</u> |
| 8. | <u>High Priority Inflow and Infiltration Reduction Program Locality Agreement with the James City Service Authority</u> |
| 9. | <u>HRSD West Point Virginia Department of Environmental Quality Enforcement Action Order by Consent</u> |
| 10. | <u>Capital Improvement Program (CIP) Update</u> |
| 11. | <u>New Business</u> |
| 12. | <u>Unfinished Business</u> |
| 13. | <u>Commissioner Comments</u> |
| 14. | <u>Informational Items</u> |
| 15. | <u>Closed Meeting</u> |
| 16. | <u>Reconvened Meeting</u> |



COMMISSION MEETING MINUTES
January 27, 2026

The Commission Chair called the virtual meeting to order at 9:00 a.m.

Name	Title	Present for Item Nos.
Rodriguez, Stephen C.	Commission Chair	1-16
Levenston, Jr., Willie	Commission Vice-Chair	1-5, 8-14,
Andrews, Elizabeth A.	Commissioner	1-4, 6-16
Glenn, Michael E.	Commissioner	1-2, 4-7, 9-15
Lakdawala, Vishnu K.	Commissioner	1-16
Stern, Nancy J.	Commissioner	1-16
Taraski, Elizabeth	Commissioner	1-16
Templeman, Ann	Commissioner	1-16

1. **Awards And Recognition**

Action: No action required.

a. New Employee Introduction

Mr. Santino Granato was recently hired as an Operations Manager in the Operations Department. He is a licensed Professional Engineer with 16 years of experience in wastewater and water process and conveyance. He holds a bachelor’s degree in engineering from Old Dominion University. Santino recently worked with Collins Engineers. Santino has experience in engineering design, project management, and operations management. He will be working with the North Shore Operations personnel on internal projects, overseeing connections to the existing system and operational support. Santino is an active participant in WEF and VWEA.

b. Commissioner Engagement/Events Participation

Memorandum of Understanding (MOU) signing with Korean Water Resources Corporation (K-Water) and Wintec Glovis - HRSD executed a three-party Memorandum of Understanding with Korean Water Resources Corporation (K-Water) and Wintec Glovis to pilot a superheated steam-based Granular Activated Carbon (GAC) reactivation technology at the SWIFT Research Center. This pilot makes HRSD the first organization in the United States to test this eco-friendly GAC reactivation process. The pilot will evaluate a more sustainable and potentially cost-effective alternative to conventional GAC reactivation methods.

COMMISSION MEETING MINUTES
January 27, 2026

The MOU signing was attended by Commission Chair Stephen Rodriguez and Commissioners Michael Glenn and Elizabeth Taraski, underscoring Commission support for HRSD’s continued leadership in innovation and environmental stewardship.



Discussion Summary: The pilot system is expected to be delivered in March, begin operations in April, and produce reactivated GAC by May, followed by testing over several months. Staff anticipate having performance results by the end of the year, pending any delays. Staff also noted the technology is already being implemented at scale in South Korea.

Public Comment: None

2. **Public Comments Not Related to Agenda** – None

COMMISSION MEETING MINUTES
January 27, 2026

3. **Consent Agenda**

Action: Approve the items listed in the Consent Agenda.

Moved: Vishnu Lakdawala
Seconded: Willie Levenston, Jr.

Ayes: 7
Nays: 0
Absent: Commissioner Glenn was absent due to a connectivity issue

Brief:

- a. Approval of minutes from previous meeting.
- b. Contract Awards (>\$200,000)
 - 1. [Digital Water Developments for Water Resource Recovery Facilities at Pilot- and Full-scale Study](#) \$200,00
 - 2. [ERP Project Management Advisory Services](#) \$400,880
 - 3. [Fleet Management \(FY26\) Crane Trucks \(Replacements #86 & #100\)](#) \$660,112
 - 4. [Spill Response Discharge & Wastewater Pump and Haul Services Contract](#)
 - Wastewater Pump and Haul Services \$6,400,000
 - Discharge and Wastewater Pump and Haul Services \$1,600,000
- c. Contract Change Orders (>25% of original contract value or \$50,000)
 - 1. [Digester No. 3 Cleaning and Residual Hauling for Atlantic Treatment Plant](#) \$213,287
 - 2. [Nansemond Treatment Plant Struvite Recovery Facility Improvements](#) \$5,139,251
- d. Task Orders (>\$200,000)
 - 1. [Great Bridge Boulevard Interceptor Force Main \(SF-164\) Segmental Replacement at Oak Bridge-Glenleigh](#) \$658,700
 - 2. [Urbanna and Central Middlesex Wastewater Treatment Plant](#) \$393,863



COMMISSION MEETING MINUTES
January 27, 2026

Rehabilitation

- | | | | |
|----|---|----------|-------------|
| 3. | <u>VIP Service Area I-I Reduction Phase I and VIP Service Area I-I Reduction Phase III</u> | | |
| | | VPO18301 | \$329,832 |
| | | VPO18303 | \$252,542 |
| 4. | <u>Williamsburg Treatment Plant Intermediate Clarifier Wet Weather and Phosphorus Removal System Improvements</u> | | \$1,171,339 |

Item(s) Removed for Discussion: None

Public Comment: None

COMMISSION MEETING MINUTES
January 27, 2026

4. **Report of the Study of the Estimated Economic Impact of HRSD and Sustainable Water Initiative for Tomorrow (SWIFT) Briefing**

Action: No action is required.

Brief: In May 2025, the Commission approved an agreement with the Old Dominion Research Foundation through Dr. Vinod Agarwal and Dr. Robert McNab from the Dragas Center for Economic Analysis and Policy and the Strome College of Business (collectively, ODU) to study and estimate some of the economic impacts of HRSD and the Sustainable Water Initiative for Tomorrow (SWIFT) project on Hampton Roads and the Commonwealth of Virginia.

Dr. McNab, will discuss the Phase One findings of their study on the economic impact of HRSD and SWIFT.

The first phase of the study summarizes the history of HRSD, how HRSD operates as a regional entity, and highlights how regional collaboration through HRSD provides an example for other entities to follow in Hampton Roads. They also examine and discuss: the regional Consent Decree and the savings from the regionalized approach of addressing capacity-related Sanitary Sewer Overflows (SSO); the need for the integrated plan and SWIFT; the economic value of mitigating local stormwater retrofits that would have otherwise been required; and estimate the economic impact associated with the projected construction and operation of SWIFT.

The second and next phase of the study will examine the potential value of replenishing groundwater supply by first reviewing the extant literature on groundwater replenishment to develop a framework for analysis. Using estimates of modeled groundwater replenishment from HRSD, they will develop a multi-year analysis of the potential value, conditioned on operational assumptions, of SWIFT's operations. The second phase of the project will be provided to HRSD no later than June 1, 2026.

This study does not include the economic effects associated with a rebound in land subsidence due to SWIFT or the potential for economic growth associated with SWIFT by allowing for an increase in water permitting to attract new companies and industries to eastern Virginia while retaining those already here. This would be another major undertaking and is beyond the current scope of this study.

Dr. McNab provided a [briefing](#) during the meeting.



COMMISSION MEETING MINUTES
January 27, 2026

Discussion Summary: Staff explained that the estimated 28,500 jobs were derived using an economic impact model based on avoided costs from semi-regionalization and the SWIFT program, totaling approximately \$5 billion in savings. These savings were modeled as increased household spending and reduced capital costs, resulting in higher employment, household income, and regional GDP.

Staff further noted that the analysis indicates the average ratepayer bill would be approximately 30% lower by 2040 as a result of semi-regionalization and SWIFT—approximately \$55 per month versus \$78 per month without these initiatives—representing an estimated annual savings of \$250 or more per ratepayer. Staff also discussed plans to develop legislative materials to communicate these findings to the General Assembly.

Public Comment: None

COMMISSION MEETING MINUTES
January 27, 2026

5. **Kempsville Interceptor Force Main Replacement – Phase I
Initial Appropriation – Non-Regulatory and Contract Award (>\$200,000)**

Actions:

- a. Appropriate project funding for preliminary engineering services in the amount of \$1,141,500.
- b. Award a contract to Kimley-Horn and Associates, Inc. in the amount of \$913,200.

Moved: Ann Templeman
Seconded: Nancy Stern

Ayes: 7
Nays: 0
Absent: Commissioner Andrews was absent due to a connectivity issue

CIP Project: AT014600

Regulatory Requirement: None

Type of Procurement: Competitive Negotiation

A Public Notice was issued on August 25, 2025. Eight firms submitted proposals on October 16, 2025, and all firms were determined to be responsive and deemed fully qualified, responsible, and suitable to the Professional Services Selection Committee (Committee) and to the requirements in the Request for Proposals (RFP). Three firms were short-listed, interviewed, and technically ranked as listed below:

Proposers	Technical Points	Recommended Selection Ranking
Kimley Horn and Associates, Inc.	91	1
Hazen and Sawyer, DPC	90	2
Black and Veatch Corporation	80	3

The Committee recommends award to Kimley Horn and Associates, Inc., whose professional qualifications and proposed services best serve the interest of HRSD.

Project Description: This project will replace 5,700 feet of 24 and 30-inch ductile iron pipe along Kempsville Road between Hunningdon Lakes Boulevard and Walton Road. The attached [map](#) depicts the project location.



COMMISSION MEETING MINUTES
January 27, 2026

Project Justification: The Interceptor Force Main (IFM) along Kempsville Road has experienced multiple failures due to internal and external corrosion. This 33,000-foot-long IFM was installed between 1972 and 1999 and consists of Prestressed Concrete Cylinder Pipe (PCCP) and Ductile Iron Pipe (DIP). Recent breaks near Hunningdon Lakes Boulevard have reconnected to DIP that shows significant evidence of internal corrosion, which is why this section of the IFM is being addressed first. Approximately 1,700 feet of this alignment was replaced in 1997 with a Virginia Department of Transportation (VDOT) Project and is not included in the replacement work.

Contract Description and Analysis of Cost: This contract is for engineering services to provide a Preliminary Engineering Report (PER) for the entire project area, 30% design of the northern project area, and additional services as deemed necessary for PER/design completion. The cost is based on the anticipated labor hours for the PER, 30% design of the northern project area, and subconsultant costs for field investigations/data analysis.

Funding Description and Analysis of Cost: The initial budget appropriation includes \$913,200 for preliminary engineering services and a 25% contingency.

<u>Schedule:</u>	PER	February 2026
	Design	February 2027
	Bid	October 2027
	Construction	December 2027
	Project Completion	March 2029

Public Comment: None

COMMISSION MEETING MINUTES
January 27, 2026

6. **CREW Carbon, Inc. Agreements for Virginia Initiative Plant and Army Base Treatment Plants
Contract Award (>\$200,00)**

Actions: Approve three joint agreements with CREW Carbon, Inc for calcium carbonate addition and carbon credits at Virginia Initiative Plant (VIP) and Army Base Treatment Plants (ABTP) and authorize the General Manager to execute same, substantially as presented, together with such changes, modifications, and deletions as the General Manager may deem necessary.

1. Data Licensing Agreement for VIP and ABTPs
2. System Lease and Chemical Supply Agreement for ABTP
3. Chemical Supply Agreement for VIP

Moved: Vishnu Lakdawala
Seconded: Elizabeth Taraski

Ayes: 7
Nays: 0
Absent: Commissioner Levenston was absent due to a connectivity issue

Type of Procurement: Competitive Negotiation

A Public Notice was issued on April 21, 2025. One firm submitted a proposal on July 8, 2025, and was determined to be responsive and deemed fully qualified, responsible, and suitable to the Selection Committee and to the requirements in the Request for Proposal. The Committee recommends award to CREW Carbon, Inc., whose professional qualifications and proposed services best serve the interest of HRSD.

Agreement Description: These are five-year agreements, renewable for an additional five years, which include but are not limited to professional and contractual services for the design, equipment lease or purchase, construction, installation, chemical supply, and operational support for full-scale alkaline chemical feed systems and data licensing agreements for the sale of carbon credits attributable at each location. HRSD has determined these systems should initially be installed at VIP and ABTP, and other plants will be evaluated for future installations. Due to the uniqueness of each plant, the terms and conditions and costs of future installations will be negotiated as separate individual agreements if needed.

These agreements involve calcium carbonate (powdered limestone) feed systems, calcium carbonate supply, and carbon credit data licensing at the VIP and the ABTPs. Together, these agreements allow HRSD to enhance treatment at both facilities while



COMMISSION MEETING MINUTES
January 27, 2026

participating in the generation and monetization of carbon credits, with HRSD retaining full operational control of its plants.

At VIP, HRSD will design, procure, install, own, operate, and maintain the calcium carbonate feed system. CREW's role is limited to supplying calcium carbonate and providing technical and operational support on an advisory basis; CREW has no responsibility for system design, installation, or operation. A separate data licensing agreement grants CREW exclusive rights to use plant and system data to generate and sell carbon credits, in exchange for license fee payments to HRSD based on verified carbon dioxide removal. This structure preserves HRSD's control over plant assets and operations while enabling participation in carbon markets.

At ABTP, HRSD will continue operating the existing pilot calcium carbonate feed system on an as-is basis, with no upgrades or modifications at this time. Under the system lease and chemical supply agreement, CREW will lease the existing system to HRSD and supply chemicals and advisory support, while HRSD operates and maintains the system. This arrangement allows HRSD to maintain the current system in the near term while gaining operational experience from VIP before deciding whether, how, and by whom any future upgrades at ABTP will be designed and installed. Any future changes would be addressed through amendments to the agreements.

The total estimated costs to be paid to CREW during the first five-year term are \$2,614,253, and the total estimated payments to be received from CREW for the data licensing agreement during the first five-year term are \$2,224,118.

HRSD's legal counsel, Norton Rose Fulbright US LLP, reviewed the agreements.

Staff provided a [briefing](#) during the meeting.

Discussion Summary: Staff advised that results from the hydro and low-DO work will be published, with some findings already presented at conferences and additional publications forthcoming as part of ongoing academic research. Staff noted the work is being shared in more targeted technical forums.

Staff reported that testing is expected to begin in August 2026, with preliminary results anticipated by October 2026 and a more informed decision point around February 2027. Discussion focused on how these results may inform the timing and scope of the VIP CIP project, including the potential to delay major capital investment to avoid overbuilding, while managing regulatory compliance risk.



COMMISSION MEETING MINUTES
January 27, 2026

Staff characterized the likelihood of success at approximately 75%, noting operational flexibility across facilities and the added benefits of SWIFT treatment, which supports phosphorus removal and provides systemwide advantages. Commissioners discussed balancing innovation risk against long-term cost savings and avoiding unnecessary capital expenditures.

Public Comment: None

COMMISSION MEETING MINUTES
January 27, 2026

7. **calDENSE Calcium Carbonate (CaCO₃) Technology and Equipment
Contract Award (>\$200,000)**

Action: Award a contract to World Water Works, Inc. (WWW) in the amount of \$957,084.

Moved: Ann Templeman

Seconded: Mike Glenn

Ayes: 7

Nays: 0

Absent: Commissioner Levenston was absent due to a connectivity issue

Type of Procurement: Sole Source

Contract Description: This contract is for purchase of a “calDENSE” calcium carbonate (CaCO₃) receiving, make down, storage, and feed system for the Virginia Initiative Treatment Plant (VIP).

inDENSE™ is a technology that was developed, patented, and is owned jointly by HRSD and DC Water. inDENSE™ intellectual Property (IP) was licensed to WWW through NEWHub in the US as the exclusive licensee for this technology. HRSD has recently developed a new IP that combines calcium carbonate (CaCO₃) addition with inDENSE™ technology, known now as calDENSE, and this new add-on technology will also be licensed exclusively to WWW through NEWHub in the US by amendment of the license agreement for the inDENSE™ family of technologies (in progress).

HRSD has worked with WWW to develop the calDENSE design and equipment package focused on the CaCO₃ receiving, make down, storage, and feed system, and the first installation of this new formal system will be constructed at VIP. The inDENSE™ hydrocyclones will likely be installed at VIP as part of a future project. However, this combination (i.e. calDENSE) already exists at Army Base Treatment Plant (ABTP), specifically the formal inDENSE™ hydrocyclone installation combined with a temporary pilot CaCO₃ receiving, make down, storage, and feed system. After learning from the calDENSE installation at VIP, HRSD will also upgrade the ABTP pilot system to this approach in the future.

This will be the first installation of its kind and will be available for other utilities to purchase directly through WWW while also generating royalty for HRSD.



COMMISSION MEETING MINUTES
January 27, 2026

Installation of calDENSE CaCO₃ equipment will be performed by a combination of HRSD staff and on call contractors. Engineering design is being performed by HRSD staff in collaboration with WWW.

Analysis of Cost: The cost is consistent with other complex chemical feed systems at HRSD. Per the license agreements for the inDENSE™ family of technologies, this package of equipment is being provided to HRSD with no royalty fees included.

This work is in accordance with the Commission Adopted Procurement Policy.

Staff provided a [briefing](#) during the meeting.

Discussion Summary: This item was discussed in connection with the preceding agenda item.

Public Comment: None

COMMISSION MEETING MINUTES
January 27, 2026

8. **High Priority Inflow and Infiltration Reduction Program
Locality Agreement with the James City Service Authority**

Action: Approve the terms and conditions of the locality agreement with the James City Service Authority for the High Priority Inflow and Infiltration Reduction Program and authorize the General Manager to execute same, substantially as presented, together with such changes, modifications and deletions as the General Manager may deem necessary.

Moved: Elizabeth Andrews
Seconded: Nancy Stern

Ayes: 7
Nays: 0
Absent: Commissioner Glenn was absent due to a connectivity issue

CIP Project: GN020310

Regulatory Requirement: Integrated Plan - HPP1 (2030 Completion)

Program Description: The purpose of the High Priority Inflow and Infiltration Reduction Program (HPIIRP) is to reduce wet weather sanitary sewer overflow (SSO) volume by implementing cost-effective inflow and infiltration (I/I) reduction projects in priority basins to achieve compliance with the requirements of the approved Regional Wet Weather Management Plan (RWWMP). Work activities may be located on Locality or HRSD-owned assets, and/or private assets/property, and may include the upsizing of gravity pipelines. The currently proposed priority basins are located in James City County, York County, and the Cities of Portsmouth, Chesapeake, and Suffolk.

Program Justification: HRSD's RWWMP identified 19 high-priority basins where I/I reduction could be implemented to cost-effectively reduce model-simulated SSOs. Under the Interim Agreement, Burns and McDonnell Engineering Company (BMCD) performed data collection and analysis on the nineteen high-priority project areas and other alternate basins identified by localities as contributors to SSOs. As a result of this analysis, BMCD developed a Comprehensive Inflow and Infiltration Reduction Plan (Plan), which concluded that only three of the original 19 basins were cost-effective for I/I reduction projects, and ultimately identified seven alternate basins recommended for incorporation into the Program. The Comprehensive Agreement approved by Commission on September 2025, includes the design and construction of the selected priority projects and post-construction flow monitoring and modeling to determine the resulting reduction in modeled SSO volume.

Agreement Description: This agreement between James City Service Authority (JCSA) and HRSD is a supplement to the 2014 Memorandum of Agreement (MOA) between HRSD and all of the Localities and is for the design and construction of improvements to sanitary sewer infrastructure in two of the identified priority basins (JCSA-3-8 and JCSA-3-6)



COMMISSION MEETING MINUTES
January 27, 2026

located in James City County area. The work includes repairs targeting removal of inflow sources as well as comprehensive rehabilitation of sewer mains, manhole and laterals as described in the Preliminary Engineering Report prepared by BMcD dated December 2025.

The current estimated costs of the construction of infrastructure improvements related to the Agreement is \$7,852,000, HRSD's legal counsel, Sands Anderson PS, has prepared and reviewed the attached [Agreement](#) in coordination with counsel for JCSA.

Some key highlights of the Agreement are:

- JCSA will have the opportunity to review and comment on the draft PER and draft final plans and specifications provided by the Design-Builder.
- HRSD, through the Design-Builder, BMcD, will construct improvements in the identified basins in substantial conformance with the final plans and specifications.
- JCSA responsibilities under the agreement include coordination with locality projects, support with right of entry agreement and easements, participation in meetings, prompt review of permits and plans, prompt notification of public inquiries, observation of construction work, and participation during the processes for substantial completion, final completion, and warranty inspections of improvements.
- JCSA will own the locality system and all infrastructure related to the improvements and will be responsible for maintenance and operation prior to the commencement of construction of the improvements and after the infrastructure is placed back in service.
- HRSD will be responsible for all costs associated with the design and construction of the improvements

<u>Schedule:</u>	Design	January 2026
	Construction	April 2026
	Project Completion	November 2027

Analysis of Cost: There is no cost associated with this Agreement, but, HRSD will be responsible for all costs associated with the design and construction of the improvements with James City County.

Public Comment: None



COMMISSION MEETING MINUTES
January 27, 2026

9. **HRSD West Point Virginia Department of Environmental Quality Enforcement
Action
Order by Consent**

Action: Accept the terms and conditions of the Order by Consent for HRSD’s West Point Treatment Plant, Virginia Pollutant Discharge Elimination System (VPDES) Permit No. VA0075434, issued by the Virginia Department of Environmental Quality (DEQ) and authorize the General Manager to execute same, substantially as presented, together with such changes, modifications and deletions as the General Manager may deem necessary.

Moved:	Willie Levenston, Jr.	Ayes:	8
Seconded:	Vishnu Lakdawala	Nays:	0

Background: In 2025, DEQ issued a Notice of Violation (NOV) for six unauthorized overflows or discharges that occurred from HRSD’s West Point Treatment Plant and its collection system. Unusually wet weather contributed to the magnitude of the overflows. In response to the NOV, HRSD noted that we have either already implemented improvements to resolve the underlying cause(s) of the event or we have existing capital improvement projects that are expected to minimize risk of future overflows or unauthorized discharges.

The Town’s collection system was challenged with inflow and infiltration issues (I/I) when we acquired it and HRSD has been steadily implementing collection system improvements since, initiating an I/I reduction program in 2000. HRSD is now engaged in Phase V and Phase VI of the collection system rehabilitation efforts, along with other improvements that will address hydraulic capacity constraints at the treatment plant and improve reliability of service.

Phase V and Phase VI collection system rehabilitation efforts had been previously hampered by property acquisition efforts. This was addressed at the August 2025 Commission meeting, where the Commission adopted two resolutions that provide for the acquisition, by condemnation if necessary, of the easements required for HRSD to proceed with the necessary improvements offered by each Capital Improvement Project (CIP) effort.

DEQ recognized the above-described on-going efforts by HRSD and did not impose any civil charges as part of this Order. The Order also does not require that HRSD identify any additional capital projects to address these overflows. There is a requirement to investigate and identify as yet unknown sources of I/I in the collection system. This is also work that Operations staff have been directing as part of our I/I reduction efforts.



COMMISSION MEETING MINUTES
January 27, 2026

Work to reduce I/I in the collection system provides dual compliance benefits. The West Point VPDES permit also requires that the facility meet secondary treatment standards for Biochemical Oxygen Demand (BOD) and Total Suspended Solids (TSS) removal. Regulatory standards for secondary treatment require 85% removal of BOD and TSS. If there is excess I/I in the collection system, the influent to a facility is diluted, making it challenging to demonstrate 85% removal of these pollutants. The West Point facility has been unable to reliably demonstrate 85% removal for BOD, due largely to the dilute nature of its influent. West Point’s VPDES permit, therefore, includes a requirement to reduce excessive I/I. HRSD has identified Phase V and Phase VI rehabilitation efforts in its annual compliance plan for the permit since 2024.

Below is a list of the existing capital projects that address the compliance needs for the West Point collection system and treatment plant along with the completion deadlines identified in the Order.

CIP	Regulatory Deadline	Status
MP014800, Small Communities Rehab Phase V	8/30/2026	In construction
MP015500, Small Communities Rehab Phase VI	6/30/2027	In construction
MP015600, West Point TP Effluent Pump Station Rehab	6/30/2028	Advertised for construction
MP015610, West Point TP Plant Generator Installation	10/31/2026	In construction
MP015700, West Point TP Secondary Clarifier System Rehab	6/30/2028	Advertised for construction

HRSD’s legal counsel AquaLaw reviewed the attached [Order](#).

Discussion Summary: Staff explained that DEQ issued a Notice of Violation in August 2025, after which HRSD collaborated with DEQ to identify the causes and mitigation measures.

Staff noted the overflows were primarily attributable to excessive inflow and infiltration (I&I) in an aging collection system, a condition HRSD has been addressing through ongoing rehabilitation efforts since 2000. The Consent Order reflects existing and already-approved projects at both the treatment facility and within the collection system, including work currently underway as part of Phases V and VI of the rehabilitation programs. Staff referenced prior Commission approval to acquire easements by condemnation, noting that easement acquisition has contributed to project delays.



COMMISSION MEETING MINUTES
January 27, 2026

Staff advised that the Consent Order formalizes anticipated project schedules and regulatory deadlines and acknowledges HRSD's proactive efforts. DEQ did not assess civil penalties, recognizing HRSD's ongoing corrective actions and the inherited condition of the system. Staff emphasized that the Consent Order aligns with work already planned and underway.

Public Comment: None



COMMISSION MEETING MINUTES
January 27, 2026

10. **Capital Improvement Program (CIP)
Update**

Action: No action is required.

Brief: Implementing the CIP continues to be a significant challenge as we address numerous regulatory requirements, SWIFT Program implementation and the need to replace aging infrastructure. Staff will provide a [briefing](#) describing the status of the CIP, financial projections, projects of significance and other issues affecting the program.

Public Comment: None

COMMISSION MEETING MINUTES
January 27, 2026

11. **New Business – None**

Public Comment: None

12. **Unfinished Business – None**

Public Comment: None

13. **Commissioner Comments – None**

14. **Informational Items**

Action: No action required.

Brief: The items listed below were presented for information.

a. [Management Reports](#)

- (1) General Manager
- (2) Communications
- (3) Engineering
- (4) Finance
- (5) Information Technology
- (6) Operations
- (7) Talent Management
- (8) Water Quality
- (9) Report of Internal Audit Activities
- (10) Arrears Payments, Current State Assessment: Summary of Results

b. [Strategic Measures Summary](#)

Discussion Summary: Staff provided several updates, including receipt of \$750,000 in FY 2026 congressionally directed spending for the Onancock pump station projects, noting additional administrative steps remaining to access the funds. Staff reported the Consent Order was signed by DEQ on January 5, following a public comment period with no comments received, and that discussions will resume with the Environmental Protection Agency (EPA) and the Department of Justice (DOJ) regarding transitioning the federal consent decree to the state level. Staff also noted the reappointment of DEQ Director Mike Rolband, citing continuity and continued collaboration.

Staff reported progress on several partnerships, including ongoing discussions with Aarhus Water on a potential AI-focused MOU and early coordination with Dominion



COMMISSION MEETING MINUTES
January 27, 2026

Energy regarding a potential digester gas–fueled linear generator. Staff noted recent approval for the Virginia Natural Gas Digester Gas project and upcoming kickoff meetings. Staff also announced the engagement of The Gaston Group as HRSD’s first regional lobbyist.

Additional updates included upcoming attendance at the River Star Business Luncheon, General Assembly activity related to PFAS and biosolids, development of a PFAS cost tracker encompassing capital and operating expenditures, and an invitation for Commissioners to attend the Utility Management Conference in March, should they be interested.

Public Comment: None

15. **Closed Meeting**

Action: Approve a motion to go into closed meeting to consider the General Manager Annual Performance Review as provided for in Code of Virginia §2.2-3711A1.

Moved: Michael Glenn

Seconded: Elizabeth Taraski

Ayes: 7

Nays: 0

Absent: Commissioner Levenston was absent due to a connectivity issue

Brief: Discussion of the performance of specific public officers, appointees or employees of any public body; and evaluation of performance where such evaluation will necessarily involve discussion of the performance of specific individuals.

Public Comment: None



COMMISSION MEETING MINUTES
January 27, 2026

16. **Reconvened Meeting**

Certificate of Proceedings: Pursuant to Section 2.2-3712.D of the Code of Virginia, we will now have a roll call vote to certify that to the best of each Commission member’s knowledge: (i) only public business matters lawfully exempted from open meeting requirements under this chapter, and (ii) only such public business matters as were identified in the motion by which the closed meeting was convened were heard, discussed or considered. Any Commissioner who believes there was a departure from these two requirements shall so state prior to the vote, indicating the substance of the departure.

Roll Call Vote:

Ayes: 7
Nays: 0
Absent: Commissioner Glenn exited the meeting at a subsequent point

Action: Approved the General Manager’s salary increase of 15.3% as recommended, effective February 23, 2026.

Moved: Willie Levenston, Jr.
Seconded: Nancy Stern

Ayes: 7
Nays: 0
Absent: Commissioner Glenn exited the meeting at a subsequent point

Next Commission Meeting Date: February 24, 2026, at the HRSD South Shore Operations Complex, 1434 Air Rail Avenue, Virginia Beach, VA 23455

Meeting Adjourned: 12:50 p.m.

SUBMITTED:

APPROVED:

Elizabeth I. Scott
Commission Secretary

Stephen C. Rodriguez
Commission Chair

HRSD Commission Meeting Minutes
January 27, 2026
Attachment #1

3. Consent Agenda

CONSENT AGENDA ITEM 3.b.1. – January 27, 2026

Subject: Digital Water Developments for Water Resource Recovery Facilities at Pilot- and Full-scale Study
Contract Award (>\$200,000)

Recommended Action: Award a contract to Université Laval in the amount of \$50,000 for six months with three renewal options and an estimated cumulative value of \$200,000.

Regulatory Requirement: None

Type of Procurement: Research Study

Contract Description: This contract supports a collaborative research agreement between Université Laval and HRSD focused on advancing Digital Water technologies for water resource recovery facilities at both pilot and full scale. The funding covers a full-time post-doctoral researcher who will develop, test, and validate advanced digital twin, hybrid modelling, machine learning, and process control approaches for wastewater treatment systems. The post-doc will conduct research primarily at Université Laval's pilEAUte pilot facility, with validation and implementation at HRSD full-scale facilities, working on applications such as intelligent disinfection dosing, autonomous controller optimization, and data pipelining. The researcher will split effort between core academic research and direct support of HRSD's Digital Water objectives, coordinating regularly with HRSD staff and conducting periodic onsite visits to Virginia.

This work is in accordance with the Commission Adopted Procurement Policy.

CONSENT AGENDA ITEM 3.b.2. – January 27, 2026

Subject: ERP Project Management Advisory Services
Contract Award (>\$200,000)

Recommended Action: Award a contract to Protiviti Government Services in the amount of \$400,880.

Regulatory Requirement: None

Type of Procurement: Competitive Negotiation

A Public Notice was issued on October 24, 2025. Thirteen firms submitted proposals on November 25, 2025, and all firms were determined to be responsive and deemed fully qualified, responsible, and suitable to the Professional Services Selection Committee (Committee) and to the requirements in the Request for Proposals. Five firms were shortlisted, interviewed, and technically ranked as listed below:

Proposers	Technical Points	Recommended Selection Ranking
Protiviti Government Services	93	1
Plante & Moran	90	2
Gartner	88	3
6E Technologies	81	4
Cherry Bekaert	78	5

The Committee recommends award to Protiviti Government Services, whose professional qualifications and proposed services best serve the interests of HRSD.

Contract Description: This contract is to provide advisory services in support of migration to the Oracle Fusion Cloud ERP. Specifically, HRSD seeks assistance with the planning and development phases of an Oracle Fusion Cloud ERP implementation and, at HRSD's discretion, project management services during the implementation phase. For a consultant to build upon the recently completed ERP Gap Analysis and work by assisting in determining the most effective strategy and roadmap for migrating to Oracle Fusion Cloud ERP. This includes providing expert guidance on migration methods, phased implementation options, and industry best practices to ensure a smooth transition that aligns with HRSD's operational needs, resource capacity, and long-term objectives.

Analysis of Cost: The labor rates, fixed price components, and support were determined to be fair and reasonable compared to similar and current contracted rates. The proposal includes a negotiated savings of \$15,000.

This work is in accordance with the Commission Adopted Procurement Policy.

CONSENT AGENDA ITEM 3.b.3. – January 27, 2026

Subject: Fleet Management (FY26) Crane Trucks (Replacements #86 & #100)
Contract Award (>\$200,000)

Recommended Action: Award a contract to Houston Freightliner, Inc., dba Houston Freightliner & Western Star in the amount of \$660,112.

CIP Project: GN021400

Regulatory Requirement: None

Type of Procurement: Use of Existing Contract Vehicle

Budget	\$2,952,842
Previous Expenditures and Encumbrances	(\$1,840,737)
Available Balance	\$1,112,105

HRSD Estimate: \$660,112

Project Description: This project will provide the replacement of aging fleet vehicles and purchase of additional vehicles to meet the needs of the organization. An itemized list of vehicles to be replaced or added is maintained by the Support Systems Division.

Project Justification: Replacement of aging vehicles will result in lower repair costs, and the purchase of additional vehicles will provide for increased staff efficiency.

Contract Description: This contract is for the purchase of two 2026 M2 106 Plus Conventional Chassis Crane Trucks. These crane trucks will replace HRSD’s current vehicles #86 and #100. Features include 350 HP motors, dual-taper leaf front suspensions, and high-roof aluminum conventional crew cabs. Upon evaluations of the Houston-Galveston Area Council (H-GAC) contract terms and conditions, as a public agency, HRSD is eligible to use the contract awarded to Houston Freightliner, Inc., dba Houston Freightliner & Western Star.

Analysis of Cost: By utilizing the cooperative contract through the H-GAC contract #HT06-20, HRSD is receiving a significant discount in pricing.

This work is in accordance with the Commission Adopted Procurement Policy.

CONSENT AGENDA ITEM 3.b.4. – January 27, 2026

Subject: Spill Response & Wastewater Pump and Haul Services Contract
Contract Award (>\$200,000)

Recommended Actions:

- a. Award a contract for Wastewater Pump and Haul Services to Atlantic Heating and Cooling Service Inc., Boggs Water & Sewage Inc., Cantrell Septic Services LLC DBA Virginia Septic, Lincoln Brothers Holdings, LLC DBA Royal Flush, MDM Septic Services Inc., The Julian Companies Incorporated, WA & J LLC DBA Goodman's Septic Tank Service, and Wind River Environmental, LLC DBA Stanley Environmental, in the estimated amount of \$160,000 each for one year with four renewal options each and an estimated cumulative value of \$6,400,000.
- b. Award a contract for Spill Response and Wastewater Pump and Haul Services to Hepaco LLC. and Superior Environmental Solutions, LLC. in the estimated amount of \$160,000 each for one year with four renewal options each and an estimated cumulative value of \$1,600,000.

Regulatory Requirement: None

Type of Procurement: Competitive Bid

In accordance with HRSD's competitive sealed bidding procedures, the Procurement Department advertised and solicited bids directly from potential bidders. The project was advertised on November 25, 2025, and ten bids were received on December 19, 2025.

Contractors were required to meet qualification requirements and bid on specific service areas. The solicitation also allowed HRSD to select any combination of contractors to fulfill the requirements of this service. All ten contractors' bids were deemed to be fully qualified and met HRSD's service requirements. Due to the nature of the services, prompt response times, and need for multiple available contractors to cover HRSDs large service area, it is in HRSD's best interest to award contracts to all submitted Contractors.

Contract Description and Analysis of Cost: These contracts are for spill response and wastewater pump and haul services on an as-needed basis for HRSD. Services include collection and hauling of liquid waste between HRSD treatment plants to designated wastewater collection systems to assist with system management during normal and emergency conditions. The contracts are broken down by service areas and vary based on the type of response needed from HRSD (standard, priority, emergency, or hurricane) at an hourly rate.

Rates are considered fair and reasonable based on competitive bidding and previous contract rates. This contract is an estimated usage contract. Work orders will be issued on an as needed basis with no guaranteed minimums.

This work is in accordance with the Commission Adopted Procurement Policy.

CONSENT AGENDA ITEM 3.c.1. – January 27, 2026

Subject: Digester No. 3 Cleaning and Residual Hauling for Atlantic Treatment Plant Contract Change Order (>25% of original contract value or \$50,000, or whichever is greater)

Recommended Action: Approve a change order to the contract with Synagro-WWT, Inc. in the amount of \$213,287.

Regulatory Requirement: None

Contract Status with Change Orders:	Amount	Cumulative % of Contract
Original Contract with Contractor	\$201,489	
Total Value of Previous Change Orders	\$0	0%
Requested Change Order	\$213,287	
Total Value of All Change Orders	\$213,287	105.86%
Revised Contract Value	\$414,776	

Contract Description: This contract is for the removal of residuals and cleaning of Digester #3 at the Atlantic Treatment Plant (ATP) as part of the planned ROCI project. This work includes mobilization, extraction, tank cleaning, processing, dewatering, hauling, disposal and demobilization.

Change Order Description: This change order is necessary because the volume of digester residual solids that had to be extracted, processed, dewatered, and disposed of from Digester #3 significantly exceeded original projections and was more than double the original estimated volumes. Digester #3 was last cleaned in 2020 during the Thermal Hydrolysis start-up, and the extent of struvite accumulation over the subsequent five years could not be fully quantified until cleaning activities were underway. Once exposed, the quantity of material present required immediate removal to maintain safe and reliable operations and to prevent delays to the ROCI project schedule.

Due to project sequencing constraints, the cleaning work could not be deferred and was completed to allow the digester to be turned over to the ROCI contractor as required. Deferring this work would have delayed the project and compromised plant operations. The remaining digester cleaning efforts will be completed under the ROCI CIP project.

Analysis of Cost: The cost is determined to be fair and reasonable based on rates submitted during the Invitation for Bid process.

This work is in accordance with the Commission Adopted Procurement Policy.

CONSENT AGENDA ITEM 3.c.2. – January 27, 2026

Subject: Nansemond Treatment Plant Struvite Recovery Facility Improvements
Contract Change Order (>25% of original contract value)

Recommended Action: Approve a change order to the contract with MEB General Contractors, Incorporated (MEB) in the amount of \$5,139,251.

CIP Project: NP013700

Regulatory Requirement: None

Contract Status with Change Orders:	Amount	Cumulative % of Contract
Original Contract with Contractor	\$29,043,990	
Total Value of Previous Change Orders	\$3,041,038	10%
Requested Change Order	\$5,139,251	
Total Value of All Change Orders	\$8,180,289	28%
Revised Contract Value	\$37,224,279	

Time (Additional Calendar Days)	431	
---------------------------------	-----	--

Project Description: This project involves the implementation of the WASSTRIP (Waste Activated Sludge Stripping to Remove Internal Phosphorus) process and improvements to the Struvite Recovery Facility (SRF). The WASSTRIP process consists of the storage of thickened WAS in a tank for a period sufficient to allow phosphorus and magnesium release, followed by post thickening, and transfer of thickened solids to digestion. The thickening filtrate (WASSATE) will be transferred to the SRF, separate from the centrate stream. This project includes the addition of a solids removal step for centrate and WASSATE and a small equalization tank for the WASSATE. The SRF upgrade includes the transition from magnesium chloride and sodium hydroxide to a magnesium oxide slaker and feed system, overall control system upgrades, additional reactor capacity, and replacement of the struvite product drying equipment. This project will be completed as one construction project in unison with Nansemond Treatment Plant (NTP) Digester Capacity Upgrades (NP014700).

Project Justification: This project will improve biological phosphorus removal reliability and decrease effluent phosphorus concentrations, which is important for the decrease in the James River waste load allocation; allow for treatment of all centrate flow through the SRF and overcome capacity limitations that currently require bypassing of some centrate; provide SRF reactor redundancy to allow for maintenance activities; improve solids dewatering performance and decrease polymer demand; nearly quadruple facility production of Crystal Green (when considering Boat Harbor flow); decrease the frequency of digester cleaning due to less struvite accumulation; and decrease operational costs associated with nuisance accumulation of struvite in piping and equipment upstream of the SRF.

Change Order Description: This change order includes five minor additions to the project via work change directives and requests for proposals and one major change from a work change directive. The largest change is for the conversion of the struvite recovery facility from MgCl₂ to MgO. This change will reduce chemical costs at the facility and increase the Crystal Green production. Based on the business case analysis presented by Hazen in June 2022. These changes to the SRF will save HRSD approximately \$7.5M over the course of 20 years, along with providing the redundancy required from the Boat Harbor Treatment Plant (BHTP) conversion. Other work under this change order includes:

- Revisions to the WASSTRIP piping plan
- Updating a flow meter location for straight run requirements
- Centrifuge flushing valve revisions - additional solenoid valves and associated electrical
- Centrifuge pump electrical stand updates - awnings for panels located outdoors
- Screens building exhaust fan replacements - found to be inoperable

Analysis of Cost: The cost is based on proposals and negotiated costs with our contractor, MEB. HDR Engineering, Inc. performed an independent analysis on each of the six changes mentioned above. In each case, the costs associated with the proposed changes have been found to be reasonable, and an award is recommended. Conversion of the SRF from MgCl₂ to MgO, Work Change Directive 18, was previously presented to the Commission in October 2025 when we requested the additional appropriation.

Schedule: Project Completion December 2026

CONSENT AGENDA ITEM 3.d.1. – January 27, 2026

Subject: Great Bridge Boulevard Interceptor Force Main (SF-164) Segmental Replacement at Oak Bridge-Glenleigh
Task Order (>\$200,000)

Recommended Action: Approve a task order with Kimley Horn and Associates, Inc. in the amount of \$658,700.

CIP Project: AT016600

Regulatory Requirement: None

Contract Status with Task Orders:	Amount
Original Contract with Engineer	\$315,000
Total Value of Previous Task Orders	\$0
Requested Task Order	\$658,700
Total Value of All Task Orders	\$658,700
Revised Contract Value	\$973,700

Project Description: This project will replace approximately 5,400 feet of 30-inch ductile iron interceptor force main (SF-164) along Great Bridge Boulevard in the City of Chesapeake. The attached [map](#) depicts the project location.

Project Justification: This project will provide for the segmental replacement of an interceptor force main on Great Bridge Boulevard, identified during FY23 condition assessment activities to have extensive pipe wall loss due to interior and exterior corrosion. The pipe segment investigated in June 2023 at the City force main connection (AT1139-3) resulted in a pinhole failure requiring the pipe to be encased in concrete (temporary repair). The remaining ductile iron pipe in this location was determined to have similar pipe wall thickness and a very high likelihood of failure (LoF = 5.0). Follow up condition assessment to the west (near AT1136-1) to confirm replacement extents observed more ductile iron pipe with significantly reduced wall thickness. Recommended replacement extents include replacement of all ductile iron pipe west of AT1193-3 to the 30-inch PVC transition point on the southeast side of Dominion Boulevard (2008) to provide for complete renewal of this section of SF-164.

Task Order Description and Analysis of Cost: This task order will provide design and pre-construction services in accordance with the approved recommendations from the Preliminary Engineering Report. The cost for this task order is based on hourly labor rates and an estimated number of labor hours considered reasonable when compared to other projects of similar size and complexity.

Schedule:	Design	February 2026
	Bid	January 2027
	Construction	April 2027
	Project Completion	September 2029



- AT016600**
- Project Interceptor Line
 - Project Interceptor Point
 - Project Location Point
 - Project Area
- Legend**
- CIP Interceptor Point
 - CIP Pump Station Point
 - CIP Interceptor Line
 - CIP Abandonment
 - CIP Project Area
 - HRSD Interceptor Force Main
 - HRSD Interceptor Gravity Main
 - HRSD Treatment Plant
 - HRSD Pressure Reducing Station
 - HRSD Pump Station

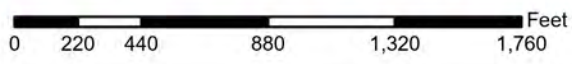

AT016600

**Great Bridge Boulevard Interceptor Force Main
(SF-164) Segmental Replacement at Oak Bridge-
Glenleigh**



CONSENT AGENDA ITEM 3.d.2. – January 27, 2026

Subject: Urbanna and Central Middlesex Wastewater Treatment Plant Rehabilitation Task Order (>\$200,000)

Recommended Action: Approve a task order with HDR Engineering Inc. (HDR), in the amount of \$393,863.

CIP Project: MP016200

Regulatory Requirement: None

Contract Status with Task Orders:	Amount
Original Contract with Engineer	\$0
Total Value of Previous Task Orders	\$0
Requested Task Order	\$393,863
Total Value of All Task Orders	\$393,863
Revised Contract Value	\$393,863

Project Description: This project will improve resiliency and/or replace the existing Urbanna and Central Middlesex Treatment Plant process assets identified in the Urbanna and Central Middlesex Treatment Plant (WWTP) Rehabilitation Cost Planning Study - Critical items.

Project Justification: The screening and equalization, BNR process, secondary clarifiers, RAS/WAS pumping, digesters, UV disinfection, sand filters, clear well, effluent manhole and parshall flume, effluent storage and pumping, solids drying beds, polymer system, administration building and miscellaneous, electrical, and instrumentation and control have reached the end of their useful life. This project will correct these deficiencies and bring both the Urbanna and Central Middlesex Treatment Plants to current HRSD standards.

Task Order Description and Analysis of Cost: This task order will provide the necessary preliminary engineering phase services for the subject project. The fee includes \$31,375 for project management during this phase, \$36,692 for tank assessments at both plants, \$250,796 for the Preliminary Engineering Report (PER) and preliminary drawings, and \$75,000 for additional services for a total of \$393,863. These costs are based on HDR's negotiated rates and are in line with other, similar efforts by other firms.

Schedule:	PER	February 2026
	Design	July 2026
	Bid	July 2027
	Construction	September 2027
	Project Completion	December 2028

CONSENT AGENDA ITEM 3.d.3. – January 27, 2026

Subject: VIP Service Area I-I Reduction Phase I and VIP Service Area I-I Reduction Phase III Task Order (>\$200,000)

Recommended Actions:

- a. Approve task orders with Brown & Caldwell in the amount of \$329,832 for VP018301.
- b. Approve task orders with Brown & Caldwell in the amount of \$252,542 for VP018303.

CIP Projects: VP018301/VP018303

Regulatory Requirement: Integrated Plan - HPP1 (2030 Completion)

Project Description: [PORT-02 and PORT-04](#) were originally general and data-driven, respectively, inflow and infiltration (I/I) reduction projects. To consolidate I-I reduction efforts, the construction portion for both projects will now fall under HRSD's High Priority Inflow and Infiltration Reduction Program (GN020310).

Project Justification: HRSD's Regional Wet Weather Management Plan (RWWMP) identified nineteen high-priority basins where I/I reduction could be implemented to cost-effectively reduce model-simulated sanitary sewer overflows (SSO). Under the Interim Agreement, Burns and McDonnell Engineering Company (BMcD) performed data collection and analysis on the nineteen high-priority project areas and other alternate basins identified by localities as contributors to SSOs. As a result of this analysis, BMcD developed a Comprehensive Inflow and Infiltration Reduction Plan (Plan), which concluded that only three of the original nineteen basins were cost-effective for I/I reduction projects, and ultimately identified seven alternate basins recommended for incorporation into the Program. An output of the Quarterly SSO Reduction Steering Committees was the evaluation of existing CIPs focused on I/I reduction. Port 02/04 were identified as ideal candidates for reduced design and construction costs under a design-build delivery method. The Comprehensive Agreement approved by Commission on September 2025, includes the design and construction of the selected priority projects and post-construction flow monitoring and modeling to determine the resulting reduction in modeled SSO volume.

As part of HRSD's Integrated Plan, a program of High Priority RWWMP Projects (HPP) will be constructed through 2030.

These projects were selected based on their ability to provide the greatest environmental and human health benefits. Further, this \$200+ million investment will significantly reduce sanitary sewer overflow volume at the 5-year level of service by 47 percent.

Task Order Description: These task orders will re-allocate existing additional service funds from the PER phase for design services for Brown & Caldwell to complete the design efforts for PORT-02/04 and submit those designs to BMcD for construction of the HRSD's High Priority Inflow and Infiltration Reduction Program (GN020310).

Analysis of Cost: The cost is based on anticipated labor rates. Original fee estimates from this project, and similar projects, were examined and a detailed review can be found in the Record of Negotiation.

<u>Schedule:</u>	Design	February 2026
	Construction	June 2026
	Project Completion	December 2028



VP018301

- Project Interceptor Line
- Project Interceptor Point
- Project Location Point
- Project Area

Legend

- CIP Interceptor Point
- CIP Pump Station Point
- CIP Interceptor Line
- CIP Abandonment
- CIP Project Area
- HRSD Interceptor Force Main
- HRSD Interceptor Gravity Main
- HRSD Treatment Plant
- HRSD Pressure Reducing Station
- HRSD Pump Station

Feet

0 360 720 1,440 2,160 2,880

VP018301

VIP Service Area I-I Reduction Phase I (PORTS)

N
W E
S

CIP Location

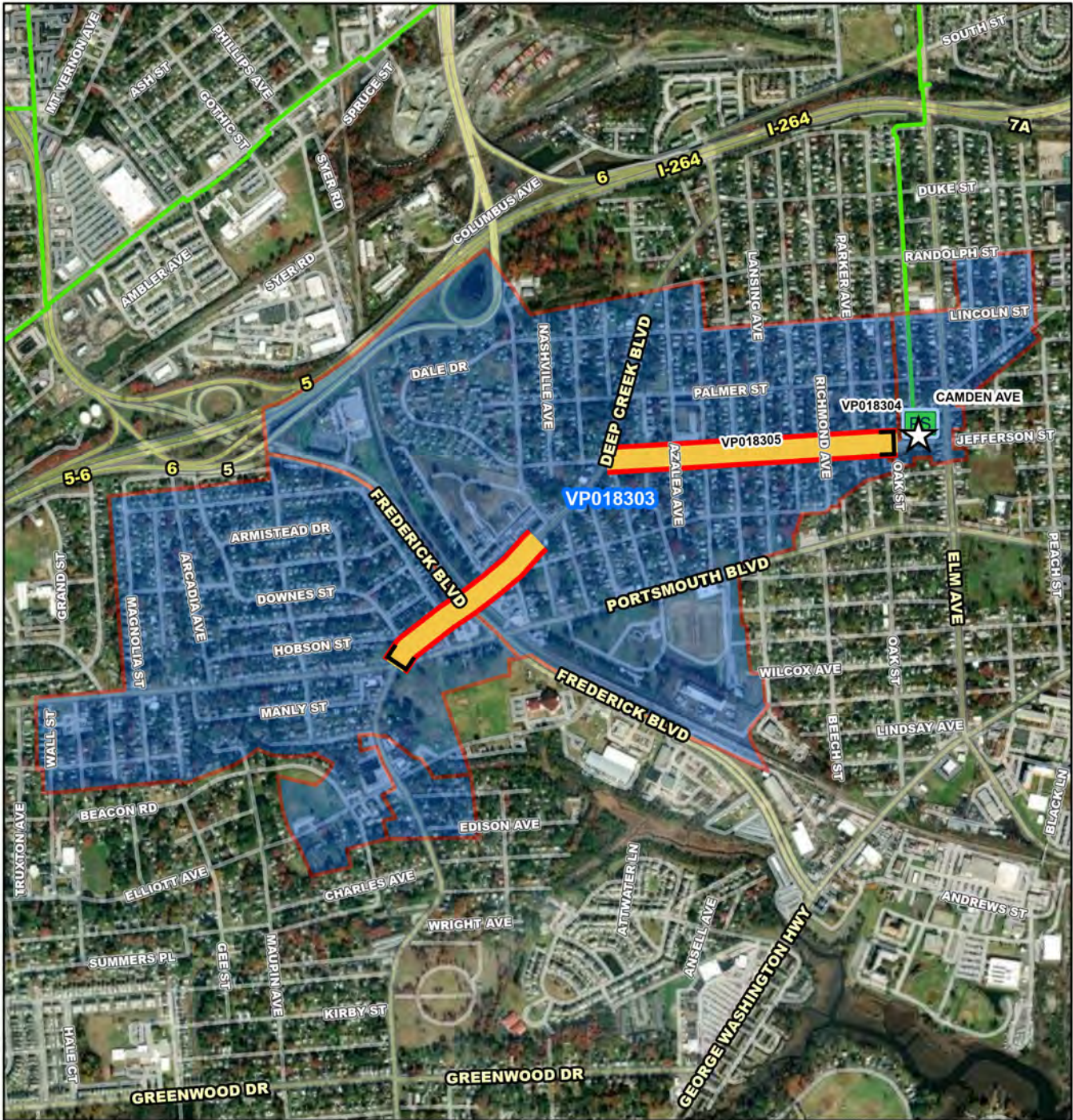

VP018303

- Project Interceptor Point
- Project Interceptor Point
- Project Location Point
- Project Area

Legend

- CIP Interceptor Point
- CIP Pump Station Point
- CIP Interceptor Line
- CIP Abandonment
- CIP Project Area
- HRSD Interceptor Force Main
- HRSD Interceptor Gravity Main
- HRSD Treatment Plant
- HRSD Pressure Reducing Station
- HRSD Pump Station

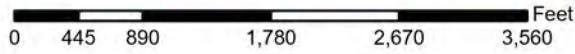

VP018303

VIP Service Area I-I Reduction Phase III (PORTS)

N
W E
S

CIP Location

CONSENT AGENDA ITEM 3.d.4. – January 27, 2026

Subject: Williamsburg Treatment Plant Intermediate Clarifier Wet Weather and Phosphorus Removal System Improvements (WB013500)
Task Order (>\$200,000)

Recommended Action: Approve a task order with Brown and Caldwell in the amount of \$1,171,339.

CIP Project: WB013500

Regulatory Requirement: Enhanced Nutrient Reduction Certainty Program (2023-2032 Completion)

Contract Status with Task Orders:	Amount
Original Contract with Engineer (Study)	\$278,770
Total Value of Previous Task Orders (PER)	\$424,390
Requested Task Order (Design)	\$1,171,339
Total Value of All Task Orders (Total Design Services)	\$1,595,729
Revised Contract Value	\$1,874,499

Project Description: This project will recommend process modifications, cost, and an implementation schedule for wet weather flow management and phosphorus removal optimization by evaluating a method to convey intermediate clarifier effluent (ICE) to the chlorine contact tanks to manage secondary clarifier solids loading during wet weather conditions. This project will also evaluate options to convey and equally split ICE to each of four aeration tanks for improved phosphorus removal.

Project Justification: This project provides a cost-effective solution for better managing wet weather flows and secondary clarifier solids loading and avoids the construction of an additional secondary clarifier or storage tanks in the interceptor system. The intermediate clarifier effluent contains nitrate/nitrite, has a low chemical oxygen demand, and is high in dissolved oxygen. These wastewater characteristics degrade the performance of biological phosphorus removal when returned to its current location upstream of aeration tank anaerobic zones. Returning intermediate clarifier effluent to the first anoxic zone of each aeration tank will bypass the anaerobic zones and improve biological phosphorus removal stability. Improved biological Phosphorus removal is needed to meet more stringent regulatory phosphorus removal requirements in 2028.

Task Order Description: This task order will provide professional engineering design and bidding services for the development of construction plans and specifications for the proposed process modifications for wet weather management and total phosphorus removal improvements at the Williamsburg Treatment Plant (WBTP). The recommended work includes Intermediate Clarifier Effluent (ICE) step feed system to the aeration basins, gravity feed of ICE to the Chlorine Contact Tanks (CCT); wet weather flow management by routing up to 12 MGD of ICE and/or primary clarifier effluent to the swing zones, wet weather equalization of ICE in the intermediate clarifier 2 and a new modulating gate at CCT2.

This project also recommends improvements such as installation of a diurnal equalization system, new effluent weirs and baffles in the secondary clarifiers and electrical upgrades at the recycle pump station and non-potable water pump station.

Analysis of Cost: The \$1,171,339 design and bidding services fee was negotiated based on a detailed estimate of labor hours, materials, subconsultant work, negotiated rates and other direct costs required to execute the agreed-upon scope. The estimated construction cost of the project at the PER phase is \$11,130,000 and the total cost of engineering services with Brown and Caldwell to date is \$1,874,499, representing approximately 16.8% of the current estimated construction cost. It is worth noting that although this ratio seems higher than expected (10%-15%), the incorporation of a study phase increased the total cost of the contract with the consultant; however, it allowed a better understanding of the plant needs for this project and an earlier evaluation of alternatives to select the proposed upgrades. The labor rates reflect the 2026 rates and are comparable with the approved rates in the General Engineering Services agreement with other consulting firms.

Based on the level of engineering effort, data collection, and development of the design plans and specifications, the negotiated amount is recommended for approval.

Schedule:	Design	February 2026
	Bid	January 2027
	Construction	May 2027
	Project Completion	November 2028

HRSD Commission Meeting Minutes

January 27, 2026

Attachment #2

4. Report of the Study of the Estimated Economic Impact of HRSD and Sustainable Water Initiative for Tomorrow (SWIFT)
Briefing



OLD DOMINION
UNIVERSITY

Hampton Roads Sanitation District (HRSD) – Economic Impact Analysis

Vinod Agarwal and Robert McNab

Dragas Center for Economic Analysis and Policy

Professors of Economics

Strome College of Business

Old Dominion University

January 27, 2026



Bottom Line Up Front

- HRSD requested that Dr. Agarwal and Dr. McNab estimate the economic impacts associated with Safe Water Initiative For Tomorrow (SWIFT). We expanded the scope to include HRSD to more accurately reflect the impact of HRSD decision making.
- **To come into compliance with Consent Orders and Consent Decrees, localities and HRSD would have had to expend \$8.24 billion.**
- Semi-regionalization reduced estimated regulatory compliance costs to \$6.80 billion.
- SWIFT will reduce estimated regulatory compliance costs to \$3.10 billion plus an additional savings of \$321.6 million in loan costs.
- **We estimate that semi-regionalization and SWIFT will generate almost 25,000 jobs and add \$3.60 billion to Virginia's Gross Domestic Product (GDP).**
- We note these estimates do not include the positive potential impacts associated with groundwater recharge.

Estimated Capital Costs and Schedule for Non-Regionalized Scenario

Jurisdiction	Regional Wet Weather Improvements	Locality Capacity Improvements	Locality / HRSD Rehab	Private Property I/I Abatement	Total CIP Costs	Schedule (Years)
Chesapeake	-	\$65.0	\$365.9	\$0.0	\$431.0	30
Gloucester	-	\$10.3	\$10.1	\$0.0	\$20.4	25
Hampton	-	\$63.4	\$209.6	\$0.0	\$273.0	25
HRSD	\$887.9	\$0.0	\$233.4	\$389.5	\$1,510.9	10/20*
Isle of Wight	-	\$0.0	\$0.2	\$0.0	\$0.2	25
James City Service Area	-	\$26.9	\$85.7	\$0.0	\$112.6	20
Newport News	-	\$72.4	\$169.4	\$0.0	\$241.8	25
Norfolk	-	\$22.0	\$572.3	\$0.0	\$594.3	25
Poquoson	-	\$1.8	\$18.9	\$0.0	\$20.6	25
Portsmouth	-	\$72.3	\$333.2	\$0.0	\$405.5	30
Smithfield	-	\$0.0	\$5.1	\$0.0	\$5.1	20
Suffolk	-	\$20.1	\$39.5	\$0.0	\$59.6	15
Surry	-	\$0.0	\$0.0	\$0.0	\$0.0	-
Virginia Beach	-	\$93.5	\$470.8	\$0.0	\$564.2	30
Williamsburg	-	\$5.5	\$22.9	\$0.0	\$28.4	20
York	-	\$0.0	\$97.6	\$0.0	\$97.6	25
TOTAL	\$887.9	\$453.2	\$2,634.7	\$389.5	\$4,365.4	-

Source: Regionalization of Sewer Systems Study (2013). All estimates in this table have been adjusted to reflect costs in millions of 2024 dollars.

Estimated Capital Improvement Costs Required to Comply With Consent Decree Non-Regionalized Scenario

Locality	Capacity Improvements (Millions)	Rehabilitation (Millions)	Private I/I Reduction (Millions)	Total CIP Cost (Millions)
Locality Total	\$453.2	\$2,401.2	\$0.0	\$2,854.5
HRSD	\$887.9	\$233.4	\$389.5	\$1,510.9
TOTAL	\$1,341.2	\$2,634.7	\$389.5	\$4,365.4

Source: Regionalization of Sewer Systems Study (2013). Prepared by HDR and McGuire Woods for Hampton Roads Planning District Commission. Includes Norfolk's estimated \$425 million in 2013 dollars for rehabilitation costs related to their individual Consent Order, which are not covered by the 2007 Regional Order and not included in the Comparative Analysis capital improvements estimates. All estimates in this table have been adjusted to reflect costs in millions of 2024 dollars.

Estimated Capital Improvements Costs Required to Comply With Consent Decree Semi-Regionalized Scenario

Locality	Locality Rehab	Private I/I Reductions	Regional Wet Weather Improvements	Upstream Capital Improvements	Total CIP COST
HRSD	\$1,353.7	\$283.5	\$855.3	\$436.5	\$2,929.0

Source: Regionalization of Sewer Systems Study (2013). Prepared by HDR and McGuire Woods for Hampton Roads Planning District Commission. "Upstream Capacity Improvements" mean larger/additional infrastructure in the locality systems required to handle peak flow. All estimates in this table have been adjusted to reflect costs in millions of 2024 dollars.

Comparison of Estimated Capital Costs Non-Regionalized and Semi-Regionalized Scenarios

	Non-Regionalized (Millions)	Regionalized (Millions)	Savings (Millions)	% Savings
Rehabilitation	\$2,634.7	\$1,353.7	\$1,281.0	48.6%
Regional Wet Weather Improvements	\$887.9	\$855.3	\$32.7	3.7%
Locality/Upstream Capacity Improvements	\$453.2	\$436.5	\$16.7	3.7%
Private Property I/I Abatement Program	\$389.5	\$283.5	\$106.1	27.2%
TOTAL	\$4,365.4	\$2,929.0	\$1,436.4	32.9%

Source: Comparative Analysis Report prepared by Brown and Caldwell, August 2013, page xiv. Data includes Norfolk's estimated \$425 million in 2013 dollars for rehabilitation costs related to their individual Consent Order, which are not covered by the 2007 Regional Order and not included in the Comparative Analysis capital improvements estimates. All estimates in this table have been adjusted to reflect costs in 2024 dollars.

Estimated MS4 Retrofit Costs Over 15 Years

Jurisdiction	Millions 2024 of Dollars
Chesapeake	\$326.3
Gloucester County	\$42.2
Hampton	\$253.4
Isle of Wight Conty	\$51.2
James City County	\$111.3
Newport News	\$286.7
Norfolk	\$358.3
Poquoson	\$17.9
Portsmouth	\$160.0
Suffolk	\$139.5
Surry County	\$9.0
Virginia Beach	\$413.4
Williamsburg	\$23.0
York County	\$120.3
TOTAL	\$2,312.5

Estimated Costs to Be Incurred by HRSD to Upgrade Its Plants to Comply with TMDL

Plants Owned and Operated by HRSD	Millions of 2024 Dollars
Army Base Plant in Norfolk (AB)	\$80.4
Williamsburg Plant (WB)	\$80.4
Virginia Initiative Plant in Norfolk (VIP)	\$160.8
York River Plant (YR)	\$26.8
James River Plant (JR)	\$293.7
Boat Harbor Plant (BH)	\$576.7
Nansemond Plant in Suffolk (NP)	\$342.0
TMDL Compliance by HRSD	\$1,560.9

Source: HRSD internal estimates based on previous upgrades. These costs would have appeared in their capital program as budgetary planning numbers.

Capital Costs to Comply With Consent Decree and Chesapeake Bay TMDL Action Plans

Compliance Costs	Non-Regionalized Scenario (Millions)	Semi-Regionalized Scenario (Millions)
TMDL Compliance by HRSD	\$1,560.9	\$1,560.9
MS4 Compliance by localities	\$2,312.5	\$2,312.5
CD Compliance by HRSD and localities	\$4,365.4	\$2,929.0
TOTAL	\$8,238.8	\$6,802.4

Source: Authors' estimates. All estimates in this table have been adjusted to reflect costs in 2024 dollars.

Estimated Capital Costs of SWIFT (Integrated Plan)

Capital Costs	Millions of 2024 Dollars
Army Base Plant in Norfolk (AB)	\$0.0
Williamsburg Plant (WB)	\$1.5
Virginia Initiative Plant in Norfolk (VIP)	\$306.7
York River Plant (YR)	\$2.3
James River Plant (JR)	\$729.3
Boat Harbor Plant (BH)	\$489.6
Nansemond Plant in Suffolk (NP)	\$1,139.4
TMDL Compliance	\$2,668.7
MS4 Compliance	\$0.0
CD Compliance	\$420.0
TOTAL	\$3,088.7

Regional Regulatory Burden of the Three Approaches

Capital Costs	Non-Regionalized Scenario (Millions)	Semi-Regionalized Scenario (Millions)	SWIFT Integrated Plan (Millions)
Army Base Plant in Norfolk (AB)	\$80.4	\$80.4	\$0.0
Williamsburg Plant (WB)	\$80.4	\$80.4	\$1.5
Virginia Initiative Plant in Norfolk (VIP)	\$160.8	\$160.8	\$306.7
York River Plant (YR)	\$26.8	\$26.8	\$2.3
James River Plant (JR)	\$293.7	\$293.7	\$729.3
Boat Harbor Plant (BH)	\$576.7	\$576.7	\$489.6
Nansemond Plant in Suffolk (NP)	\$342.0	\$342.0	\$1,139.4
TMDL Compliance by HRSD	\$1,560.9	\$1,560.9	\$2,668.7
MS4 Compliance by localities	\$2,312.5	\$2,312.5	\$0.0
CD Compliance	\$4,365.4	\$2,929.0	\$420.0
TOTAL	\$8,238.8	\$6,802.4	\$3,088.7

Sources: Authors' estimates, HRSD CIP Plan Budget Estimates and HRSD's Swift Budget. All estimates in this table have been adjusted to reflect costs in 2024 dollars.

Financing of SWIFT Budget

Funding Sources	Amount (Millions)	Percent
Subsidized Loans from WIFIA (2020 and 2021)	\$877.2	28.4%
Subsidized Loans from CWRLF (2020 and 2022)	\$255.2	8.3%
ARPA Grants	\$72.7	2.4%
RTP Grant	\$0.3	0.0%
Cash and Bonds	\$1,883.3	61.0%
TOTAL	\$3,088.7	100.0%

Notes: WIFIA is Water Infrastructure Finance and Innovation Act. CWRLF is Clean Water Revolving Loan Fund. ARPA is American Rescue Plan Act of 2021. RTP is Recreational Trails Program. All amounts in 2024 dollars.

Savings Realized from WIFIA and CWRLF Loans

Tranche	WIFIA/CWRLF Loans	Non-Subsidized Loan Rate	WIFIA/CWRLF Subsidized Rate	Present Value (2024 Dollars)
Tranche 1 (2020)	\$225,865,648	4.01%	1.42%	\$93,794,305
Tranche 2 (2021)	\$521,309,733	4.01%	1.95%	\$144,826,792
CWRLF 1 (2020)	\$100,005,000	3.64%	1.15%	\$39,356,667
CWRLF 2 (2022)	\$125,000,000	3.64%	1.30%	\$43,596,253
				\$321,574,017

Loan Program	Loan Amount in Nominal Dollars	Present Value in 2024 Dolalrs
WIFIA	\$747,175,381	\$238,621,097
CWRLF	\$225,005,000	\$82,952,920
TOTAL	\$972,180,381	\$321,574,017

Regulatory Compliance and Reduction in Marginal Costs

	Regulatory Compliance Costs (Millions)	Reduction in Ratepayer Costs (Millions)	Reduction in Loan Costs (Millions)	Total Reduction in Costs (Millions)
Non-Regionalized Approach	\$8,238	---	---	---
Semi-Regionalized Approach	\$6,802	\$1,436	---	\$1,436
SWIFT	\$3,088	\$3,713	\$321.6	\$4,035
TOTAL		\$5,150	\$321.6	\$5,472

Economic Impacts Semi-Regionalization and SWIFT

	Employment	Labor Income (Millions)	Value Added (Millions)	Outputs (Millions)
Semi-Regionalization	7,480	\$446.3	\$924.5	\$1,447.9
SWIFT	21,013	\$1,286.9	\$2,669.0	\$4,179.0
TOTAL	28,492	\$1,733.2	\$3,593.5	\$5,626.9

Summary

- In total, semi-regionalization and SWIFT will result in the creation of almost 28,500 jobs by increasing household income relative to the non-regionalized baseline.
- In other words, if HRSD had not undertaken semi-regionalization and SWIFT, there would be 28,500 fewer jobs across the Commonwealth.
- Semi-regionalization and SWIFT added \$3,593.5 million to Virginia's GDP.
- Given the increases in construction and materials costs since the 2013 regionalization study, our estimates represent a lower bound on the economic impacts associated with semi-regionalization and SWIFT.
- We note these estimates do not include the positive potential impacts associated with groundwater recharge.

Next Steps

- Semi-regionalization and SWIFT reduced costs by at least \$5.5 billion in 2024 dollars relative to the non-regionalized scenario.
- SWIFT injects treated wastewater into the aquifer. Recharging the aquifer slows saltwater intrusion and reduces (if not reverses) land subsidence.
- **SWIFT's benefits are spread out among jurisdictions that draw upon the aquifer even though a significant proportion of SWIFT's costs are borne by HRSD ratepayers.**
- In the second phase of the project, we will investigate the economic impacts associated with SWIFT's recharge of the aquifer.
- We expect to present these results in the summer of 2026.

HRSD Commission Meeting Minutes
January 27, 2026
Attachment #3

5. Kempsville Interceptor Force Main Replacement – Phase I
Initial Appropriation – Non-Regulatory and Contract Award (>\$200,000)
Map

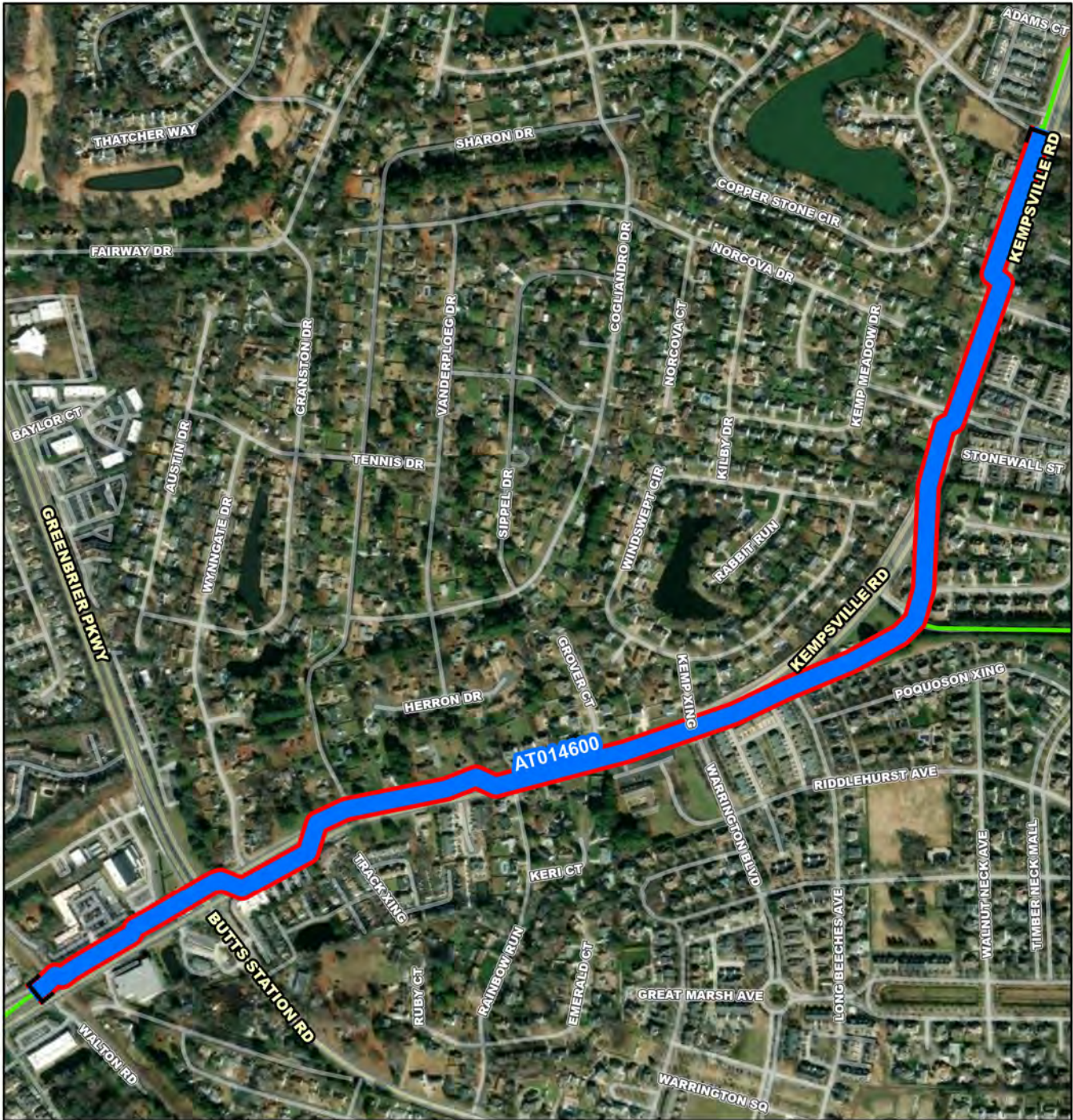

AT014600

- Project Interceptor Line
- Project Interceptor Point
- Project Location Point
- Project Area

Legend

- CIP Interceptor Point
- CIP Pump Station Point
- CIP Interceptor Line
- CIP Abandonment
- CIP Project Area
- HRSD Interceptor Force Main
- HRSD Interceptor Gravity Main
- HRSD Treatment Plant
- HRSD Pressure Reducing Station
- HRSD Pump Station

0 250 500 1,000 1,500 2,000 Feet

AT014600

Kempsville Interceptor Force Main Replacement - Phase I

CIP Location

7415.64015893105

HRSD Commission Meeting Minutes

January 27, 2026

Attachment #4

6. CREW Carbon, Inc. Agreements for Virginia Initiative Plant and Army Base Treatment Plants Briefing

HRSD's Phosphorus Story: Improving the Performance of Biological Phosphorus Removal

(no PdNA today...)

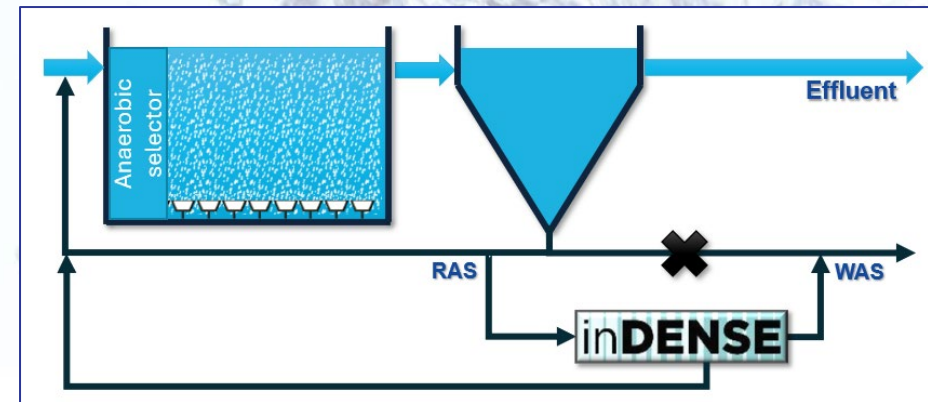
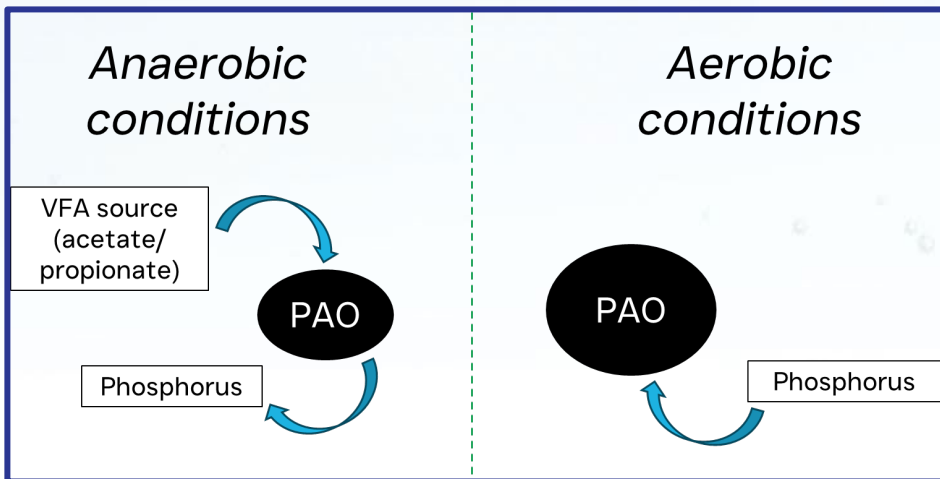

CREW
CARBON



HRSD
Sustainable, Innovative Wastewater Treatment



UNIVERSITÉ
LAVAL

Some key HRSD P Team Members - Introductions

Matt Poe, PE Director of Treatment VIP and ABTP

Ali Gagnon, PE Treatment Process Engineer VIP and ABTP

Lily McIntosh, EIT VT PhD Candidate & HRSD Research Intern

Riley Doyle, EIT Laval PhD Student & HRSD Research Intern

How do we remove Phosphorus?

- Chemical P removal (chemP)
- Biological P removal (bioP)
- Typical: BioP backed up or supplemented by chemP
- *Low TP limits require very low effluent turbidity or suspended solids – normally tertiary filtration required*

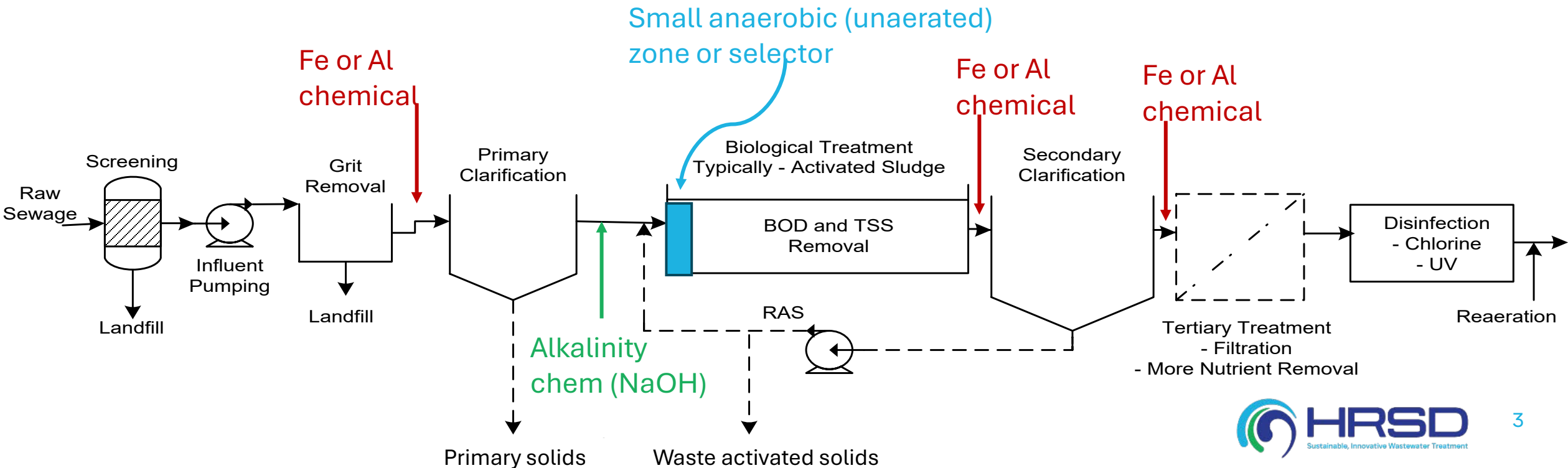

Chemical Phosphorus Removal (chemP = BAD...)

Chemicals:

- Alum = aluminum sulfate = $\text{Al}_2(\text{SO}_4)_3$
- Ferric chloride = FeCl_3
- Ferric sulfate = $\text{Fe}_2(\text{SO}_4)_3$
- Advantages:
 - Reliable.
- Disadvantages:
 - Chemical = \$
 - Consumption of alkalinity = more NaOH = more \$
 - Produces more solids = more \$
 - Low TP limits require exponentially more chemical

Biological P Removal depends on Polyphosphate-accumulating organisms (PAOs)

Anaerobic conditions

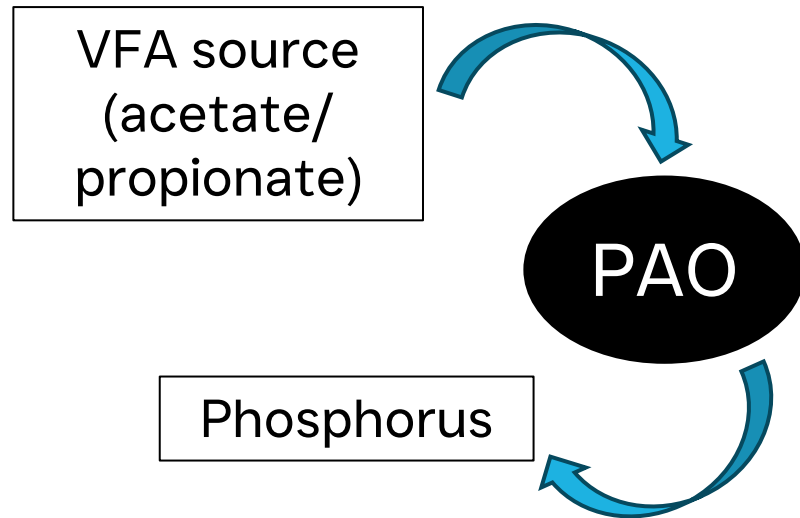

Aerobic conditions

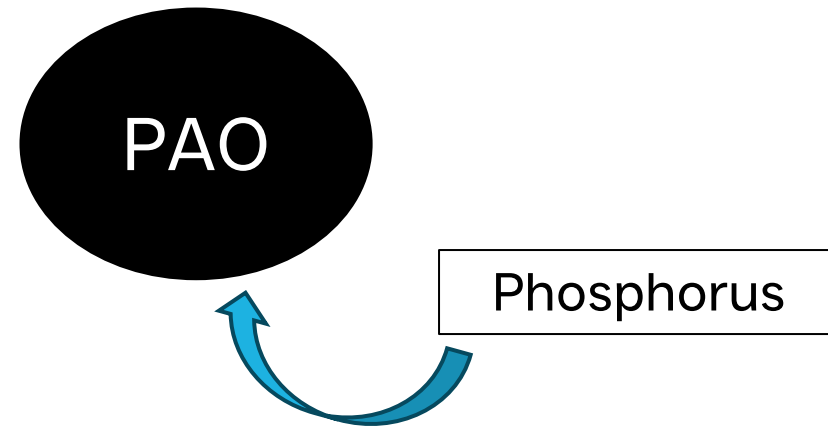

HRSD has been working on bioP for many years....

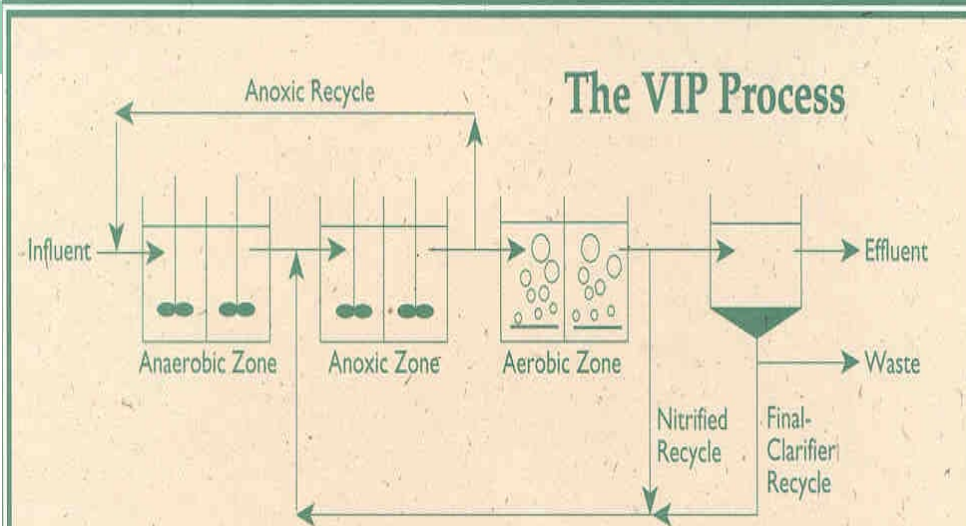

- Developed and patented by HRSD and CH2M Hill with Virginia Tech as a collaborator.
- First US installation of a process intentionally targeted at both N and P removal – all bioP

United States Patent [19] •
Daigger et al.

[11] **Patent Number:** 4,867,883
 [45] **Date of Patent:** Sep. 19, 1989

[54] **HIGH-RATE BIOLOGICAL WASTE WATER TREATMENT PROCESS USING ACTIVATED SLUDGE RECYCLE**

[75] **Inventors:** Glen T. Daigger, Englewood, Colo.; James R. Borberg, Virginia Beach; Liliana M. Morales, Reston, both of Va.

[73] **Assignee:** Hampton Roads Sanitation District of the Commonwealth of Virginia, Virginia Beach, Va.

[21] **Appl. No.:** 205,858

[22] **Filed:** Jun. 13, 1988

Related U.S. Application Data

[63] Continuation of Ser. No. 40,826, Apr. 21, 1987, abandoned.

[51] **Int. Cl.⁴** C02F 3/30

[52] **U.S. Cl.** 210/605; 210/622; 210/630; 210/903; 210/906

[58] **Field of Search** 210/605, 612, 614, 622, 210/624, 626, 630, 903, 906

[56] **References Cited**

U.S. PATENT DOCUMENTS

4,183,809 1/1980 Klopwijk et al. 210/903 X
 4,522,722 6/1985 Nicholas 210/605
 4,655,925 4/1987 Tabata et al. 210/906 X

Primary Examiner—Tom Wyse
Attorney, Agent, or Firm—Nixon & Vanderhye

[57] **ABSTRACT**

A high-rate biological waste water treatment process for removing organic matter, phosphorus and nitrogen nutrients from municipal waste water comprising the steps of mixing the influent waste water in an initial anaerobic reactor zone to maintain the biological solvents in suspension with a denitrified mixed liquor from a downstream anoxic reactor zone, typically at a flow rate of 0.5 to two times the waste water flow rate. The reactor zone serves to select microorganisms capable of accumulating quantities of phosphorus in excess of that required for simple cell growth and reproduction. The phosphorus removal occurs due to the removal of excess sludge (waste activated sludge) produced in the process wherein such sludge can be removed from the clarifier underflow or as a mixed liquor directly from the biological reactor.

14 Claims, 4 Drawing Sheets

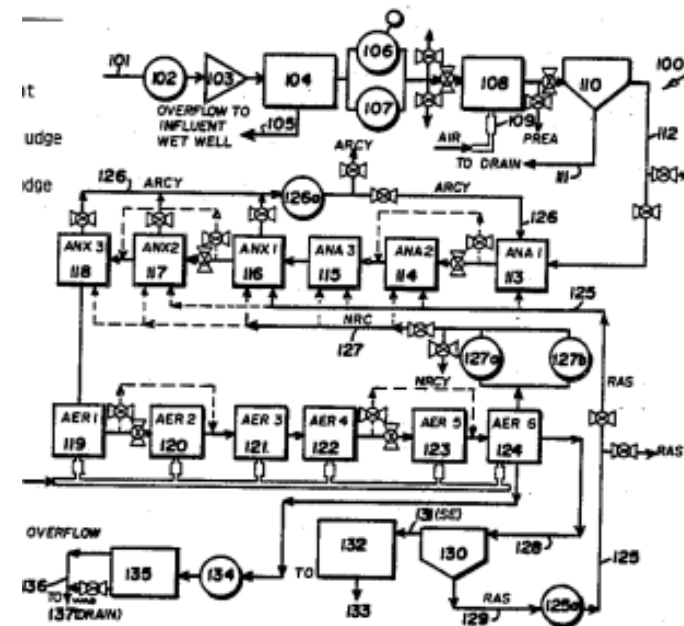

What do we think we know about BioP?

1. Need sufficient food for PAOs – acetate & propionate = VFAs
2. Minimize or prevent dissolved oxygen (DO) or nitrate input to anaerobic zone
3. Minimize P release in clarifier blanket or oversized post anoxic zone
4. Manage/minimize recycle loads from solids handling
5. Operate at DO \geq 2 mg/L in aerobic zone at all times
6. Manage glycogen accumulating organism (GAO) competition:
 - Performance will suffer in the summer...
 - Operation at solids retention time (SRT) as low as possible
 - Avoid low pH
 - Avoid high DO

BioP can produce variable effluent quality due to:

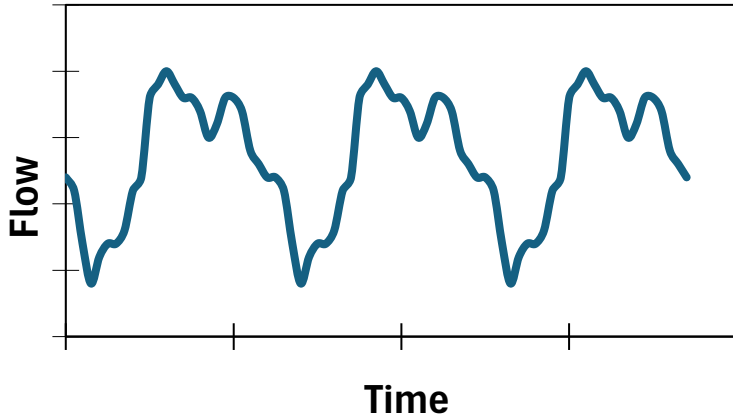

Fluctuating Loading

- Wet weather
- Diurnal variation
- Sidestream loads

Insufficient Anaerobic Conditions

- Lack of VFAs (food)
- Presence of nitrate

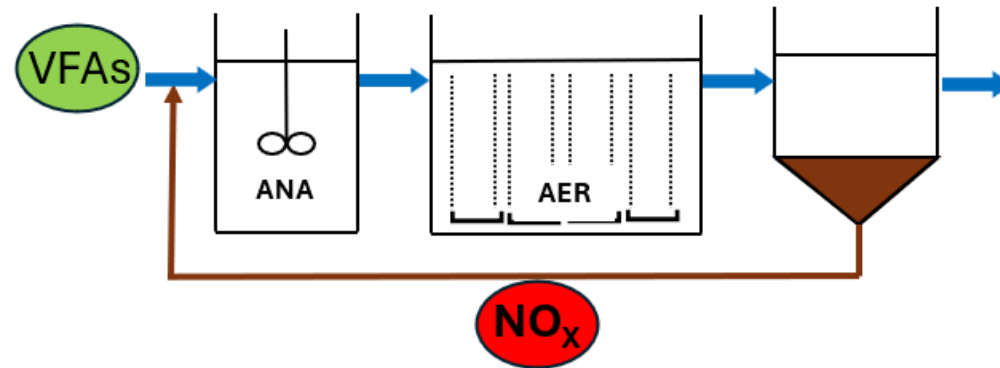
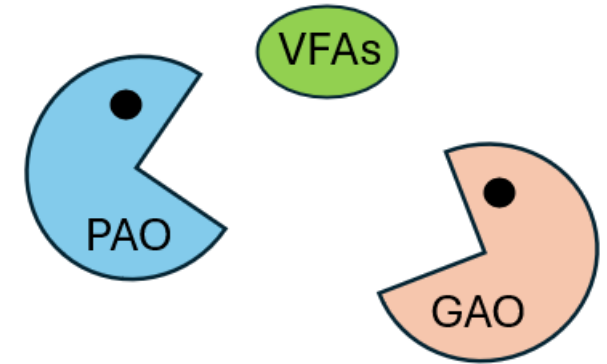

GAO Competition

- High Temperature
- High aerobic SRT
- Low pH
- High DO???

P Removal Performance – Recent years

Plant	TP (mg/L)	TP Limit (mg/L)	Notes
Army Base	0.72	0.7 target & 1.0	BioP with some recycles from solids handling, periodic alum addition
James River	0.49	0.7 target & 2.0	BioP , sidestream return load managed with a small dose of alum/ferric
Nansemond	0.87	1.0 target & 2.0	BioP , sidestream struvite recovery, periodic ferric addition
VIP	0.62	0.7 target & 1.0	BioP , periodic alum addition
Williamsburg	0.84	0.7 target & 2.0	BioP , sidestream return load managed with a small dose of alum, periodic alum addition
York River	0.26	0.3 target & 0.7	BioP + filtration , sidestream return load managed with a small dose of alum/ferric, periodic alum/ferric addition
King William	0.12	0.3	ChemP with alum and membrane , but periodic bioP encouraged
West Point	3 - 4	No limit or target	No P removal, can do some chemP if needed
Onancock	0.1 - 0.2	0.3	ChemP with alum and membrane , but periodic bioP encouraged

2026 Required P Removal Performance

Plant	TP (mg/L)	Notes
Army Base	0.7	BioP , periodic alum addition
James River	0.8	BioP , sidestream return load managed with a small dose of alum/ferric
Nansemond	1.0	BioP , sidestream struvite recovery, periodic ferric addition
VIP	0.7	BioP , periodic alum addition
Williamsburg	0.7	BioP , sidestream return load managed with a small dose of alum, periodic alum addition
York River	0.3	BioP + filtration , sidestream return load managed with a small dose of alum/ferric, periodic alum/ferric addition

2032 – Our Current Plan for Compliance

Limit = equivalent discharged load = 0.3 mg/L * Treated Flow [lbs TP/year]

Plant	TP (mg/L)	Notes
Army Base	0.6	BioP and do as well as reasonably possible, periodic alum addition
James River	0.3 65% recharge	BioP , sidestream return load managed with a small dose of alum/ferric, Floc/Sed/Biofilt, SWIFT Recharge
Nansemond	0.3 65% recharge	BioP , sidestream struvite recovery, MgO and WASTRIP, periodic ferric addition, Floc/Sed/Biofilt SWIFT Recharge
VIP	0.3	BioP , periodic alum addition, chemP polishing with Floc and Cloth Media Filtration
Williamsburg	0.6	BioP and do as well as reasonably possible, sidestream return load managed with a small dose of alum, periodic alum addition
<i>Permit compliance</i>	-20.5%	<i>Without SWIFT Recharge</i>
<i>Permit compliance</i>	11.3%	<i>With SWIFT Recharge</i>

SWIFT Research Center (1 MGD)

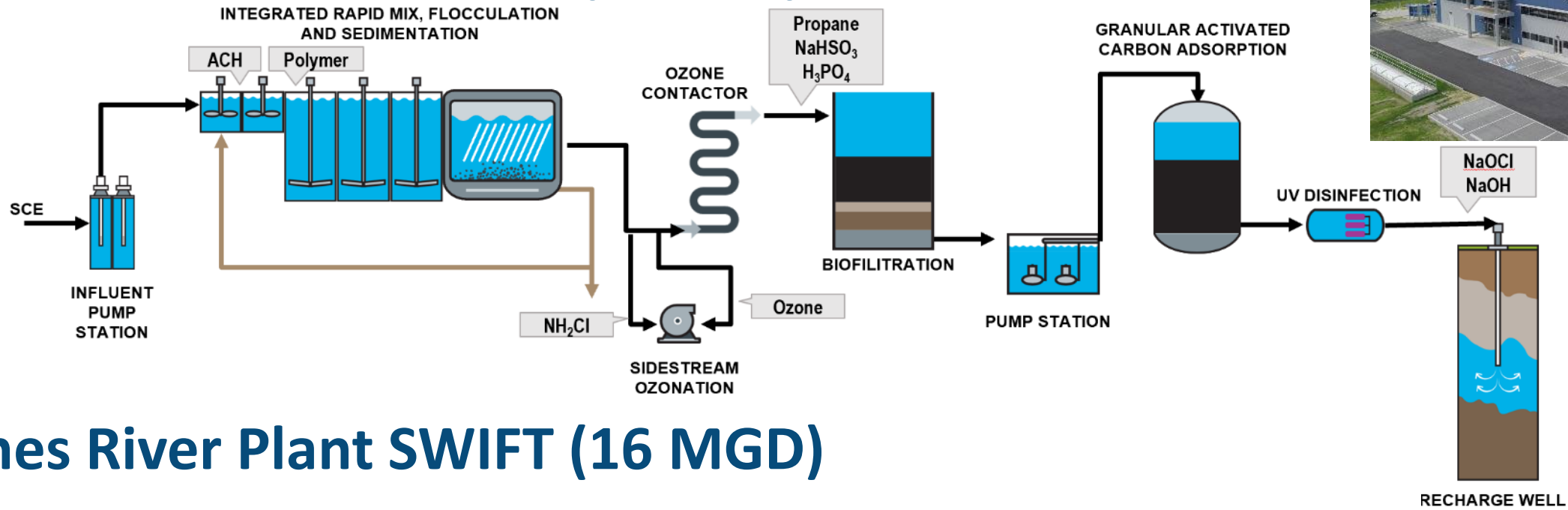

James River Plant SWIFT (16 MGD)

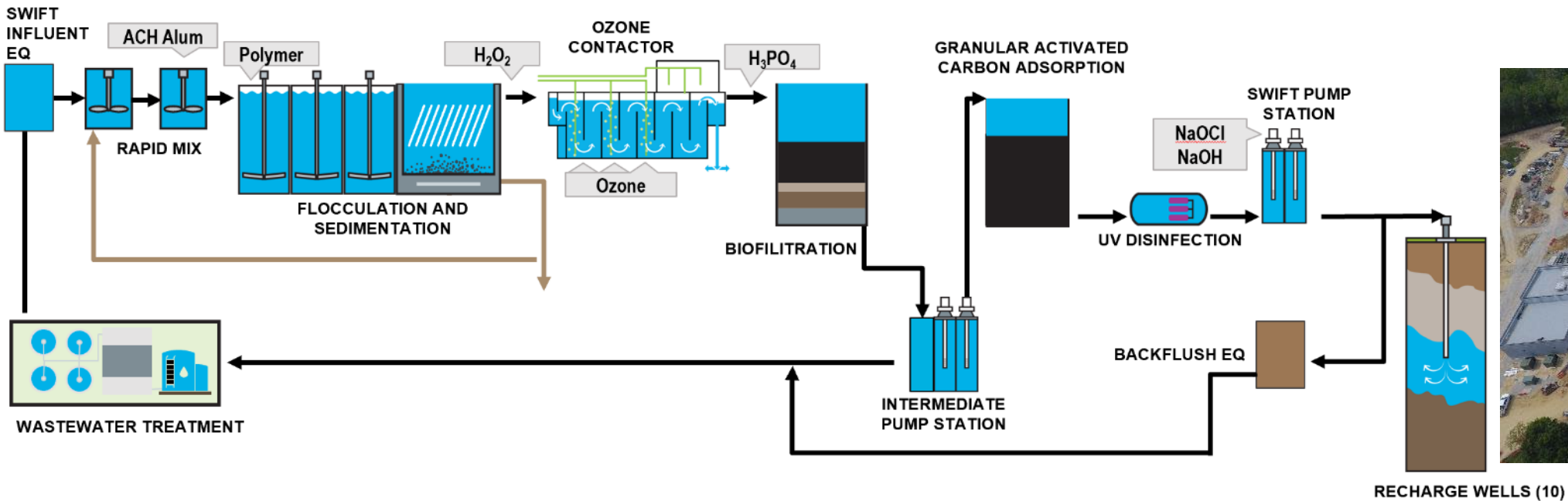

2032 – Our Current Plan for Compliance

Limit = equivalent discharged load = 0.3 mg/L * Treated Flow [lbs TP/year]

Plant	TP (mg/L)	Notes
Army Base	0.6	BioP and do as well as reasonably possible, periodic alum addition
James River	0.3 65% recharge	BioP , sidestream return load managed with a small dose of alum/ferric, Floc/Sed/Biofilt, SWIFT Recharge
Nansemond	0.3 65% recharge	BioP , sidestream struvite recovery, MgO and WASTRIP, periodic ferric addition, Floc/Sed/Biofilt SWIFT Recharge
VIP	0.3	BioP , periodic alum addition, chemP polishing with Floc and Cloth Media Filtration
Williamsburg	0.6	BioP and do as well as reasonably possible, sidestream return load managed with a small dose of alum, periodic alum addition
<i>Permit compliance</i>	<i>-20.5%</i>	<i>Without SWIFT Recharge</i>
<i>Permit compliance</i>	<i>11.3%</i>	<i>With SWIFT Recharge</i>

VIP ChemP Polishing & Tertiary Filter CIP Project

VIP Tertiary Treatment		Program Cost
GN016390	Preliminary Engineering	\$5.57M
GN016391	Site Work	\$52.9M
GN016392	Tertiary Treatment Upgrade	\$269M

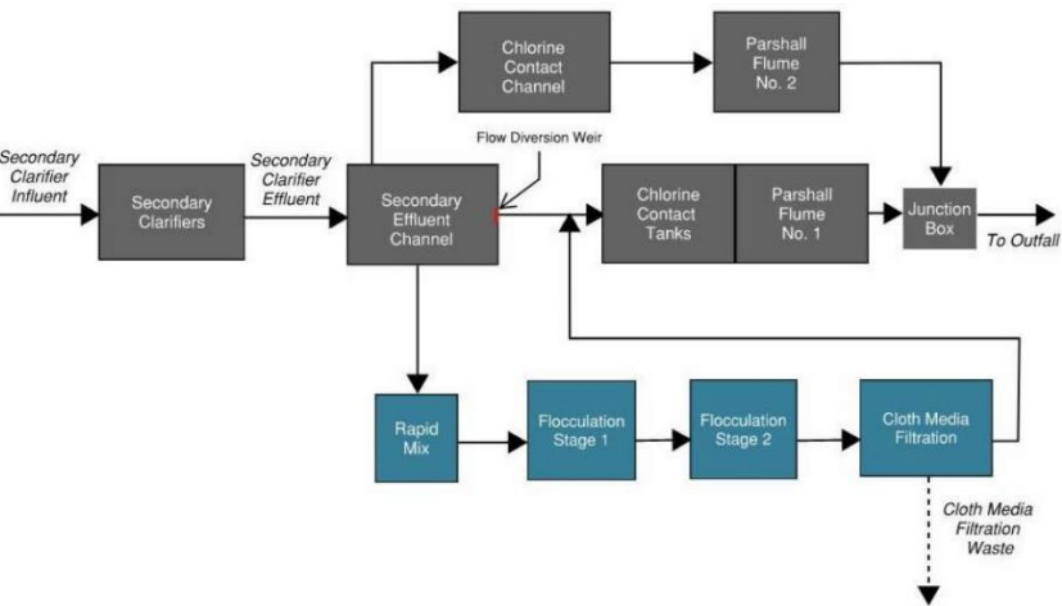

VIP ChemP Polishing & Tertiary Filter CIP Project

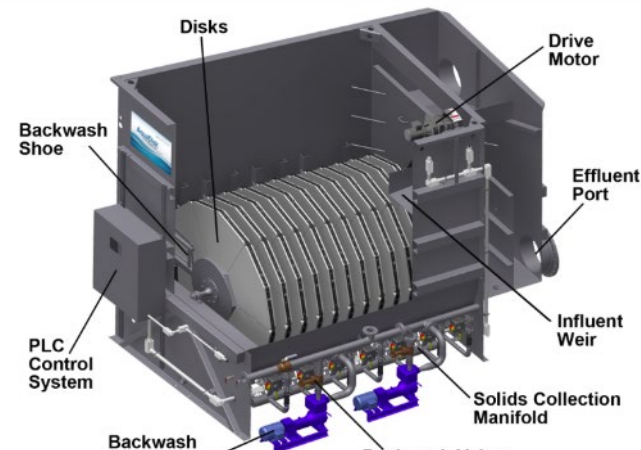
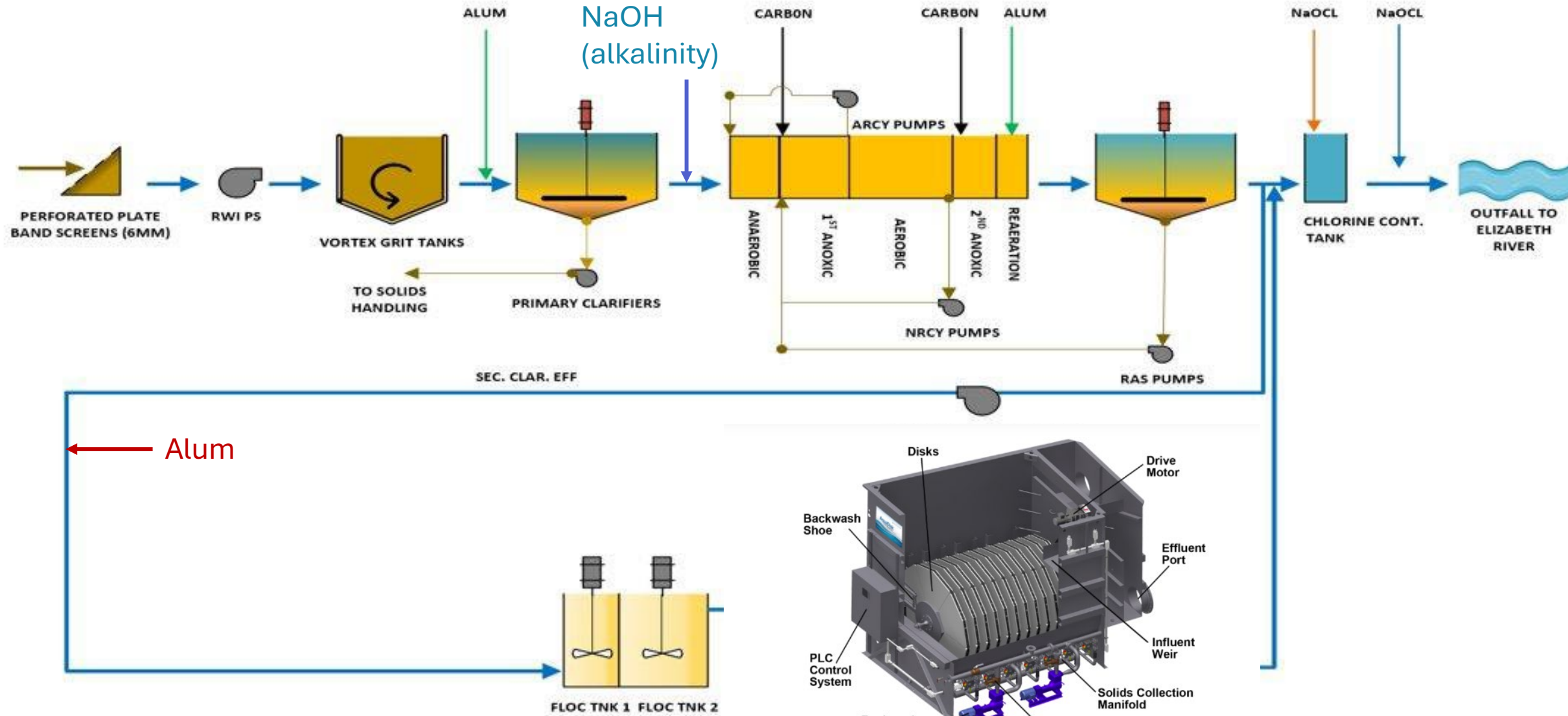

Chemical (alum) requirements for VIP Tertiary Treatment

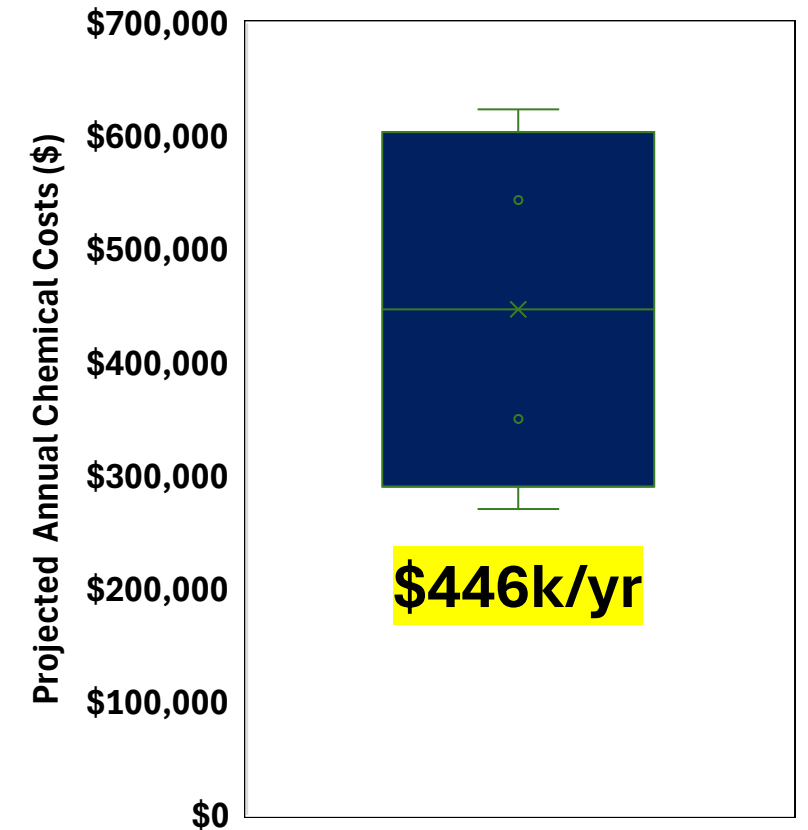
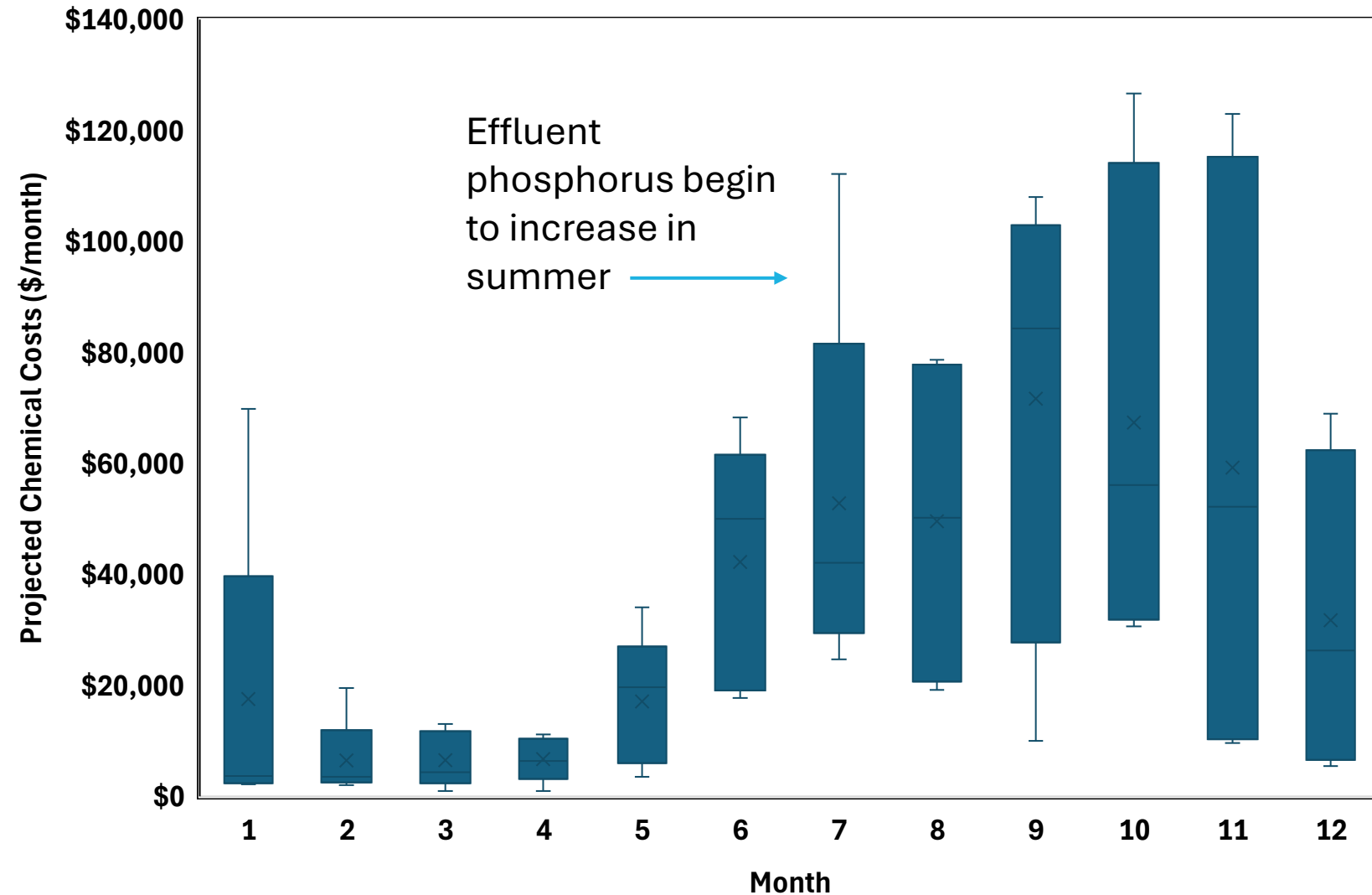

■ CMF

What can we do to improve BioP?

- Improve BioP reliability – warm summer temperatures are the issue
- Ensure consistent low turbidity secondary clarifier effluent
- SWIFT “locks us into” bioP with chemP polishing at JRTP and NTP
- What can we do at WBTP, ABTP, and VIP?

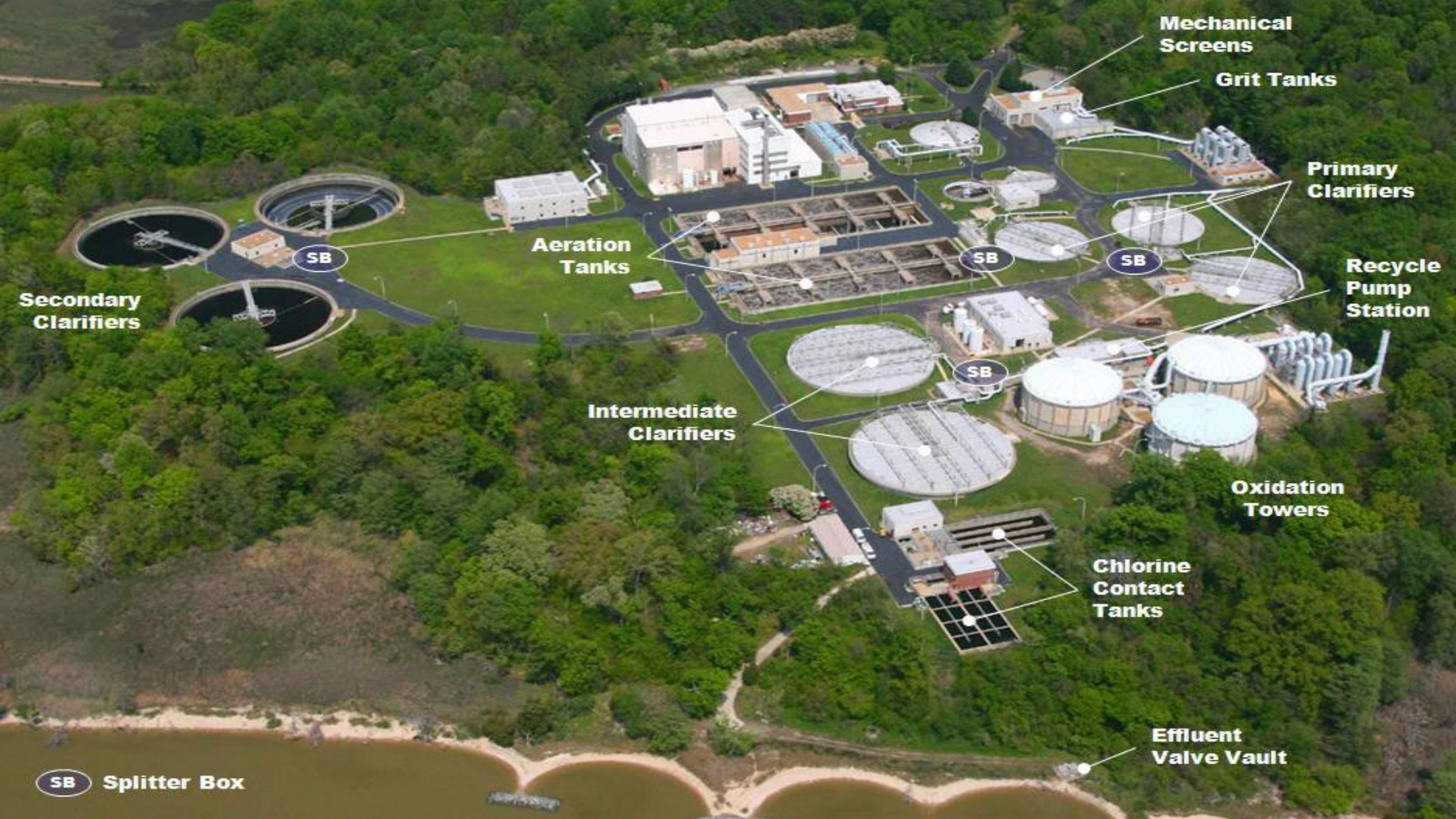

Mechanical Screens

Grit Tanks

Primary Clarifiers

Recycle Pump Station

Oxidation Towers

Chlorine Contact Tanks

Effluent Valve Vault

Aeration Tanks

Secondary Clarifiers

Intermediate Clarifiers

SB Splitter Box

SB

SB

SB

SB

Current Williamsburg Treatment Plant (WBTP) Process Flow Diagram

Sewage Treatment

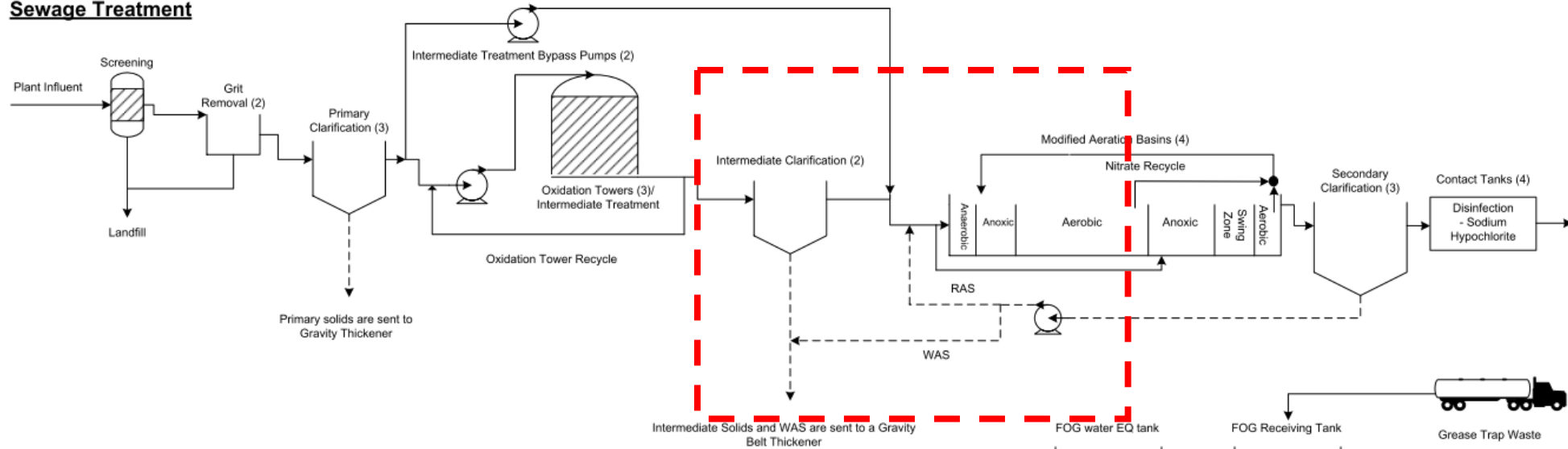

Solids Handling

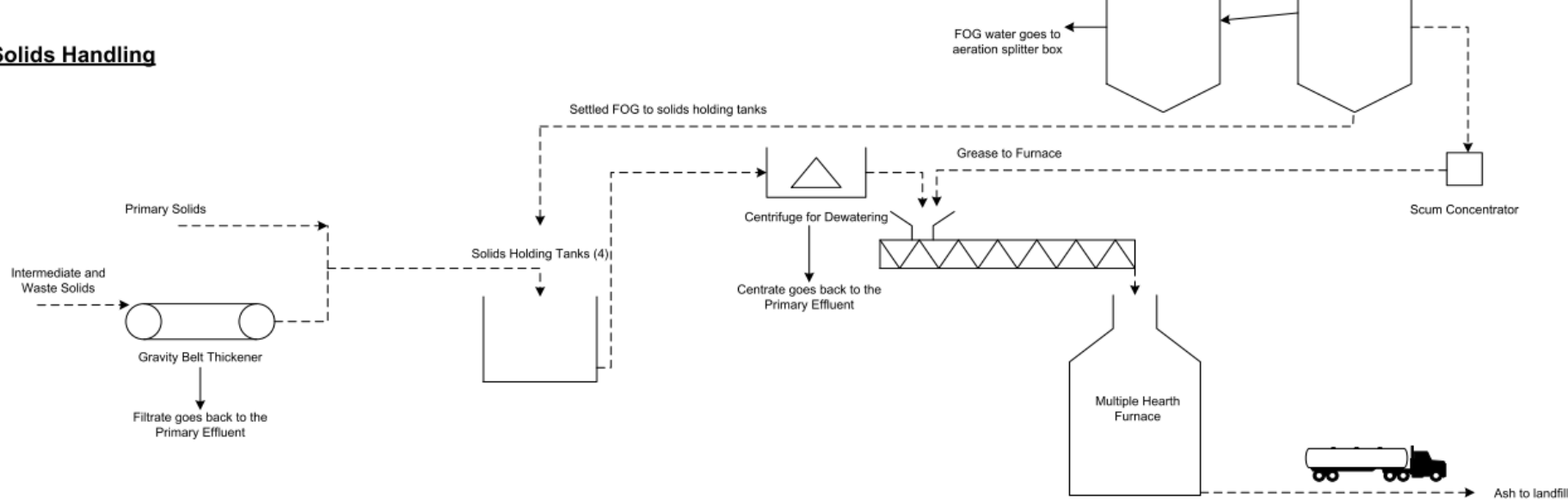

Current Williamsburg Treatment Plant (WBTP) Process Flow Diagram

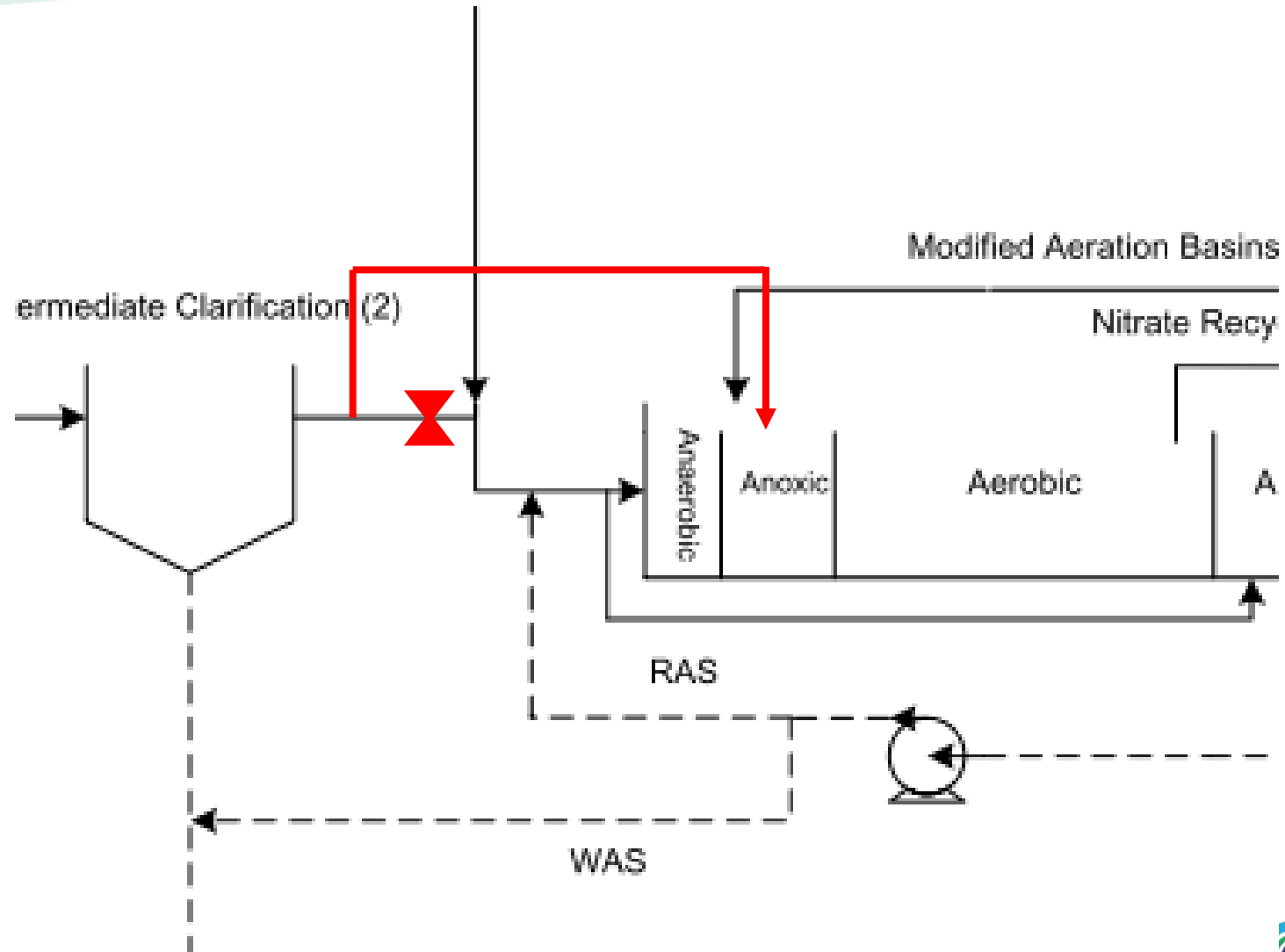

Intermediate Clarifier Effluent (ICE) Step Feed

CIP WB013500

WBTP Intermediate Clarifier Wet Weather & Phosphorus Removal System Improvements

Total cost = \$11.7M

ICE Step Feed portion = \$4.9M

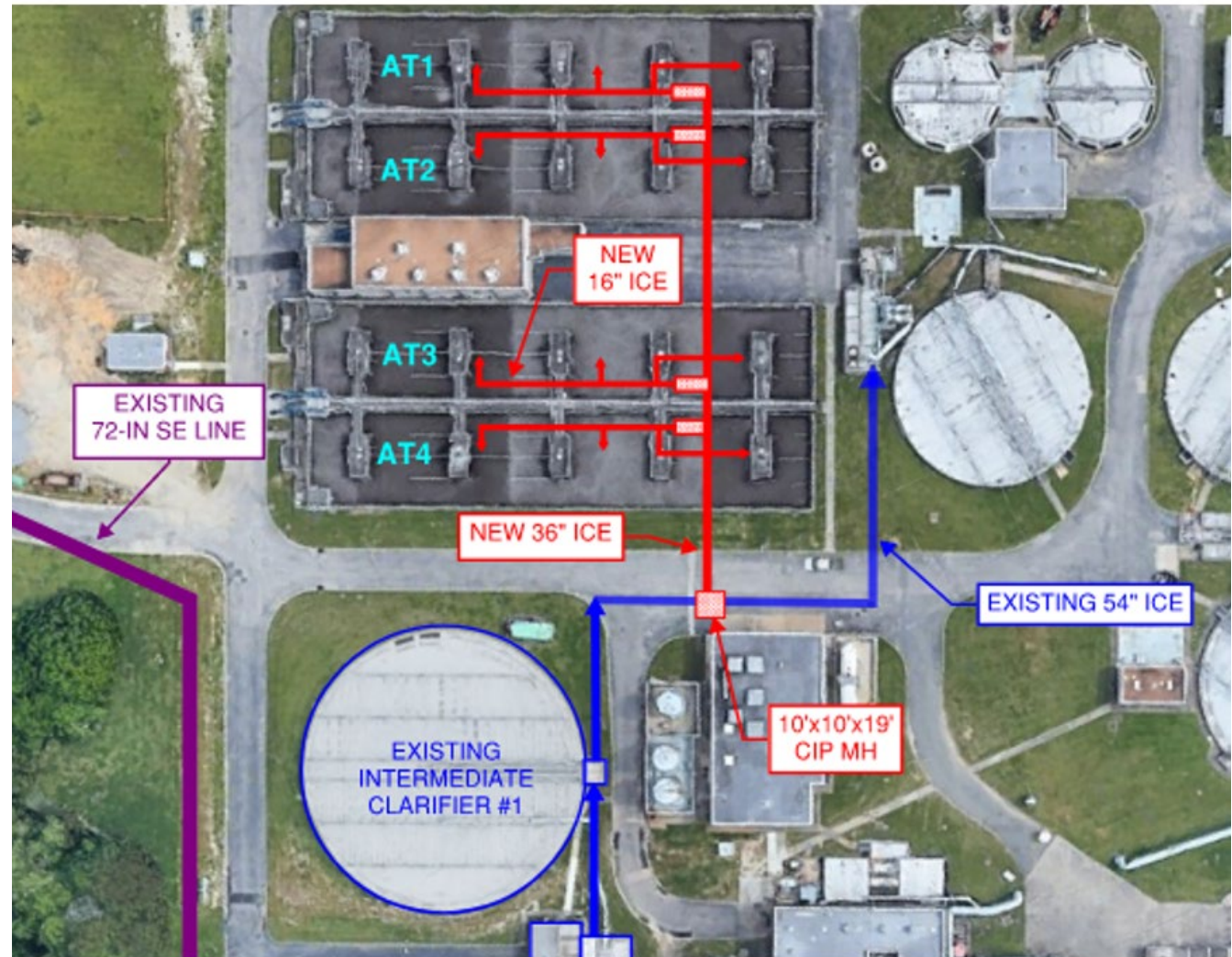

Low DO BioP has been studied at VIP full-scale and the VIP BNR Pilot

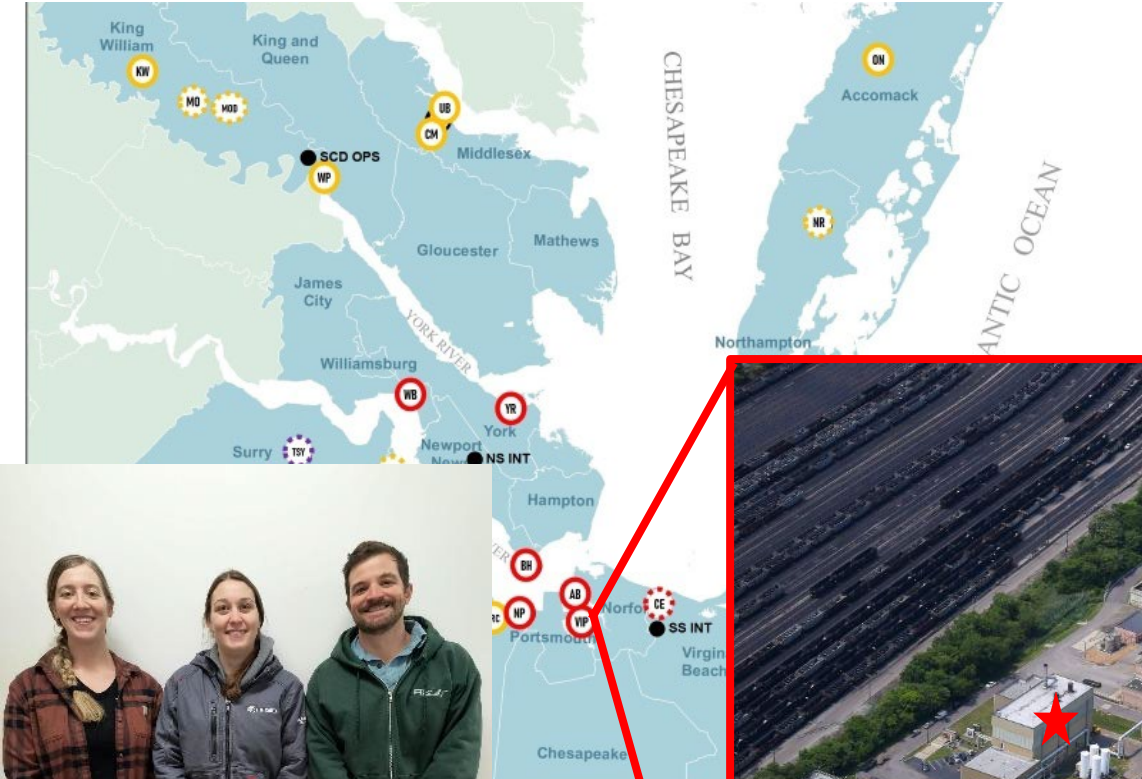

★ VIP Pilot



Motivations and Challenges associated with low DO

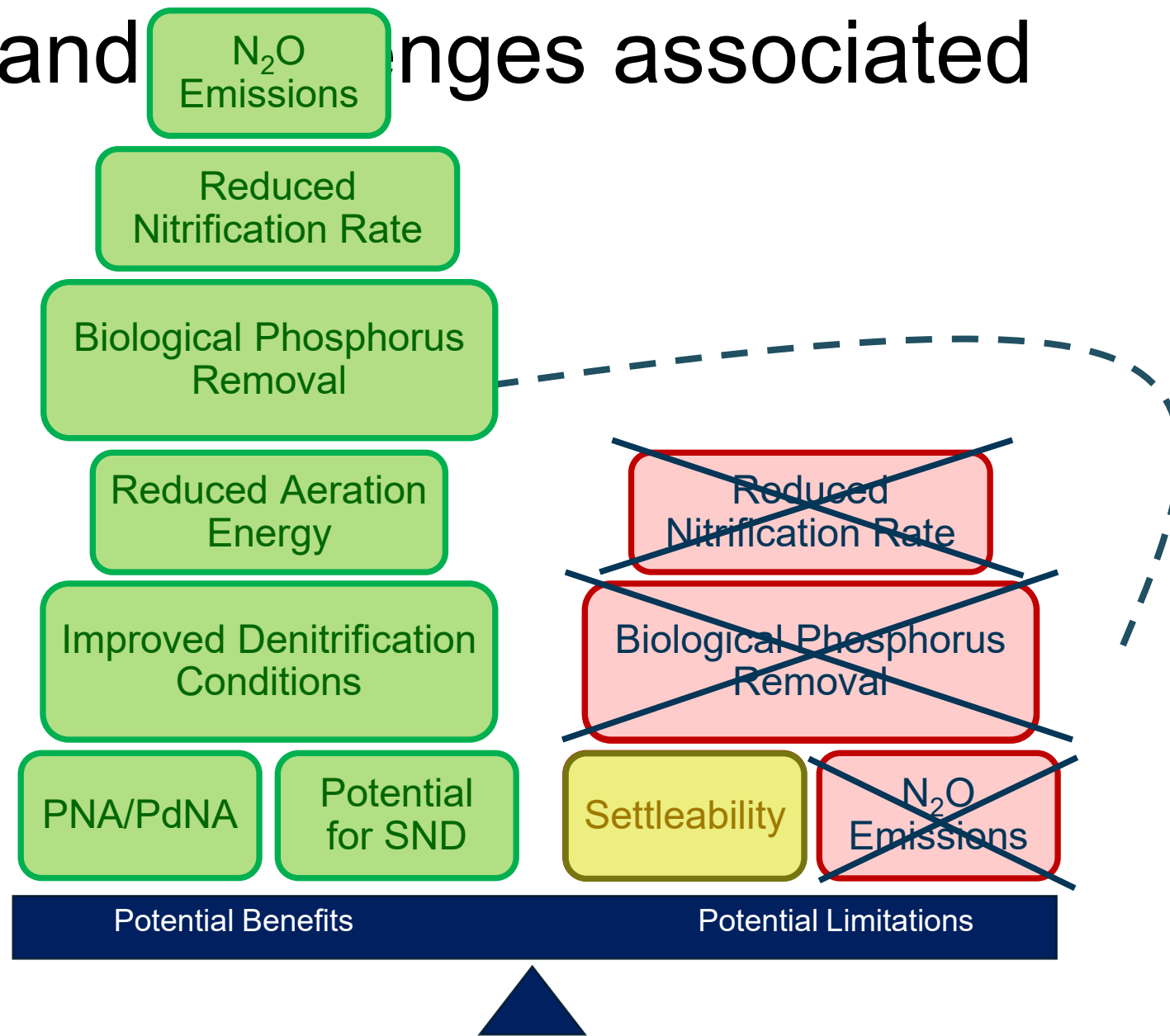

Motivations and challenges associated with low DO

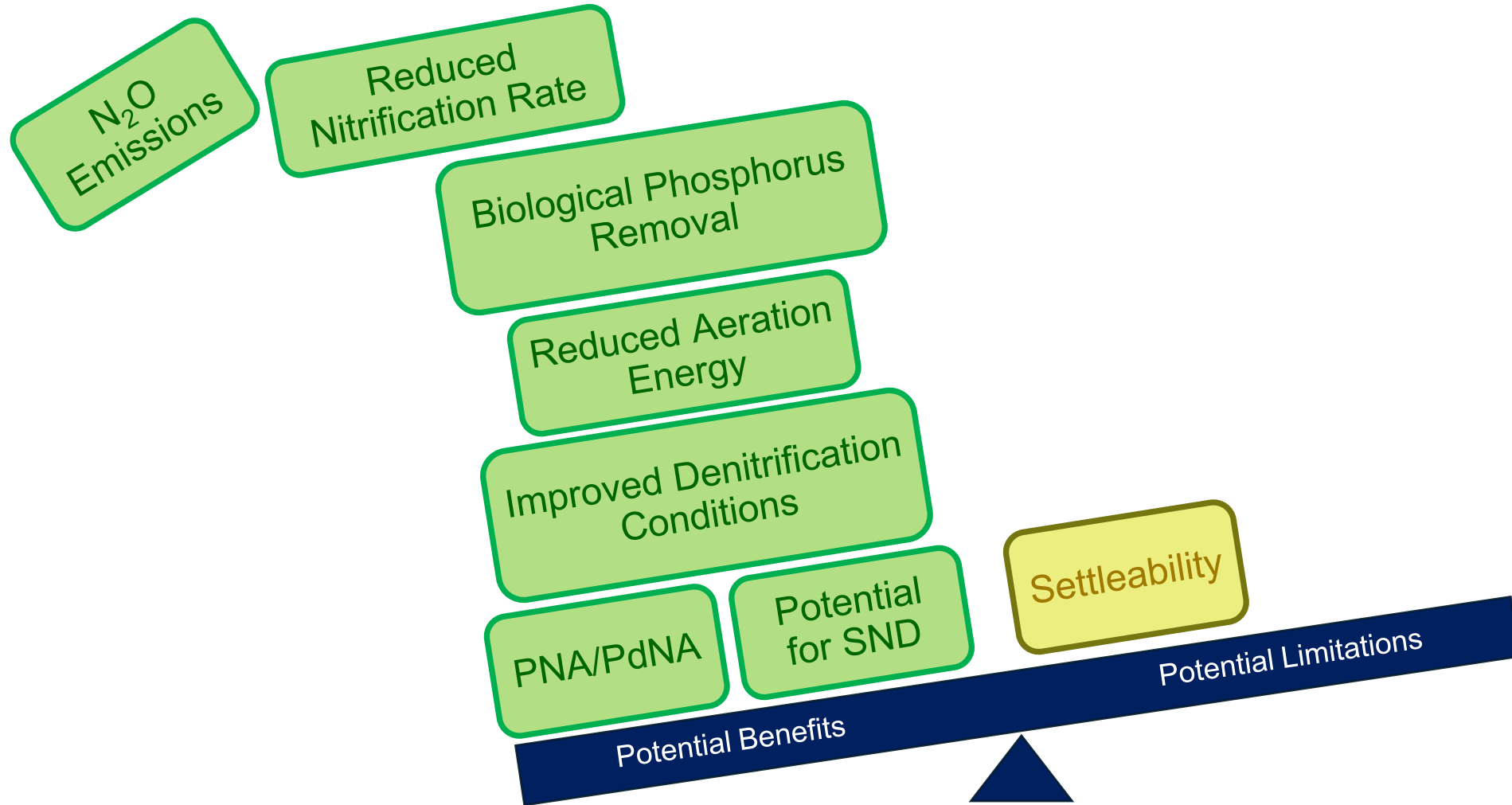

Effluent P quality has improved without alum at VIP

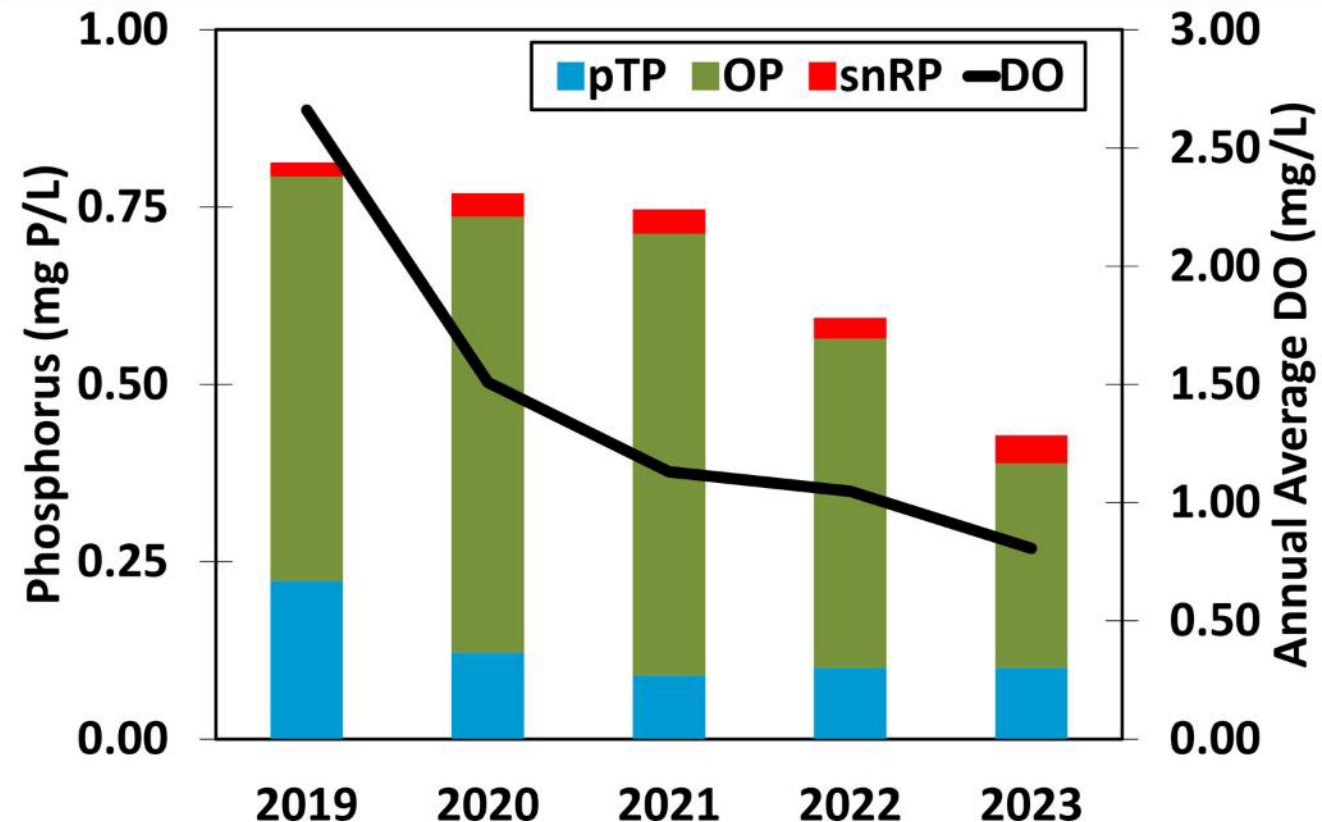
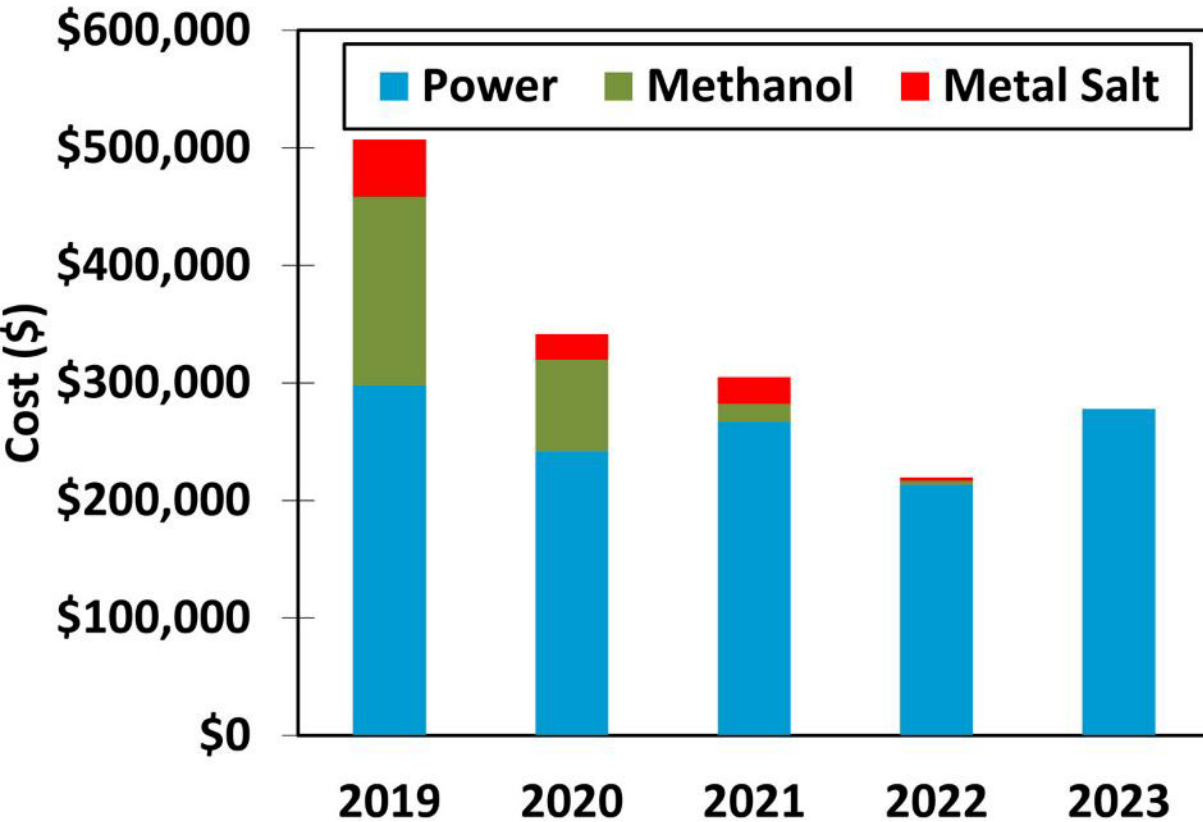

Phosphorus release and uptake rates increased with low DO at VIP, even in the summer

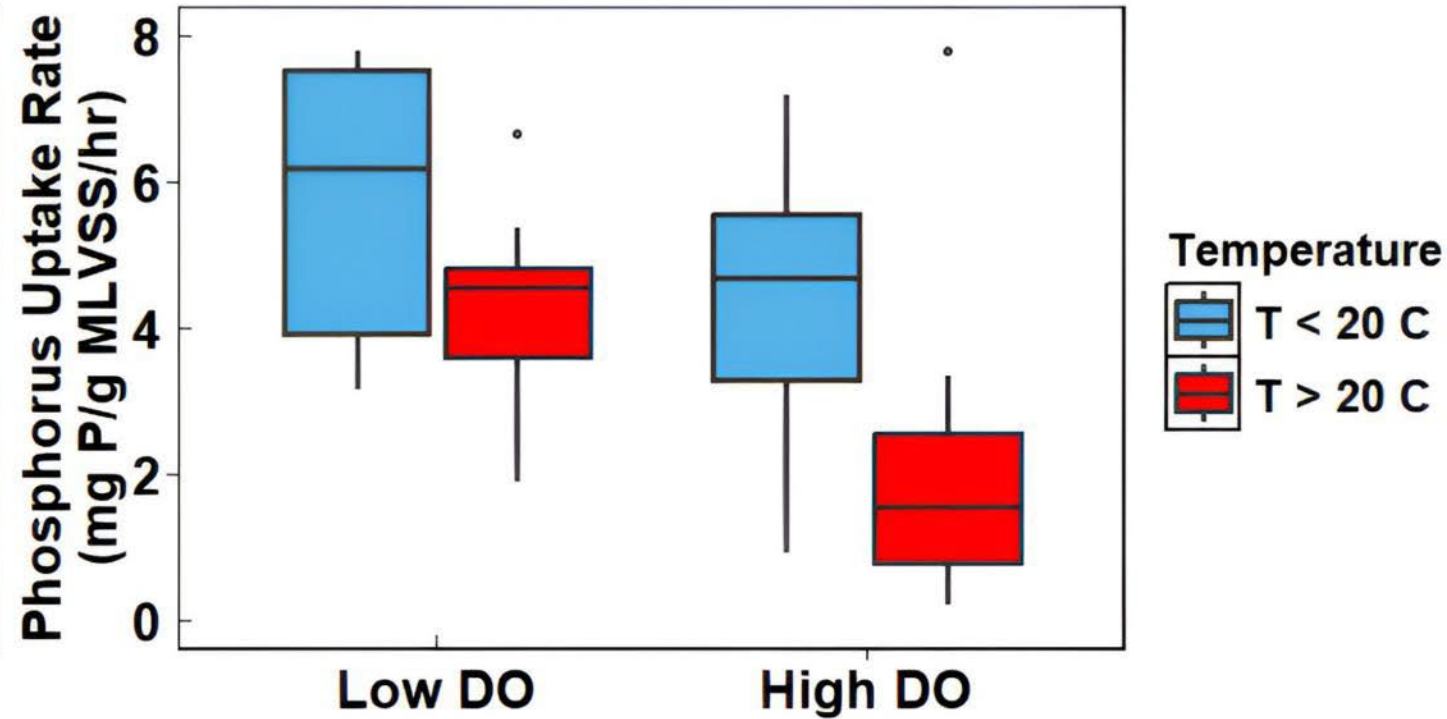
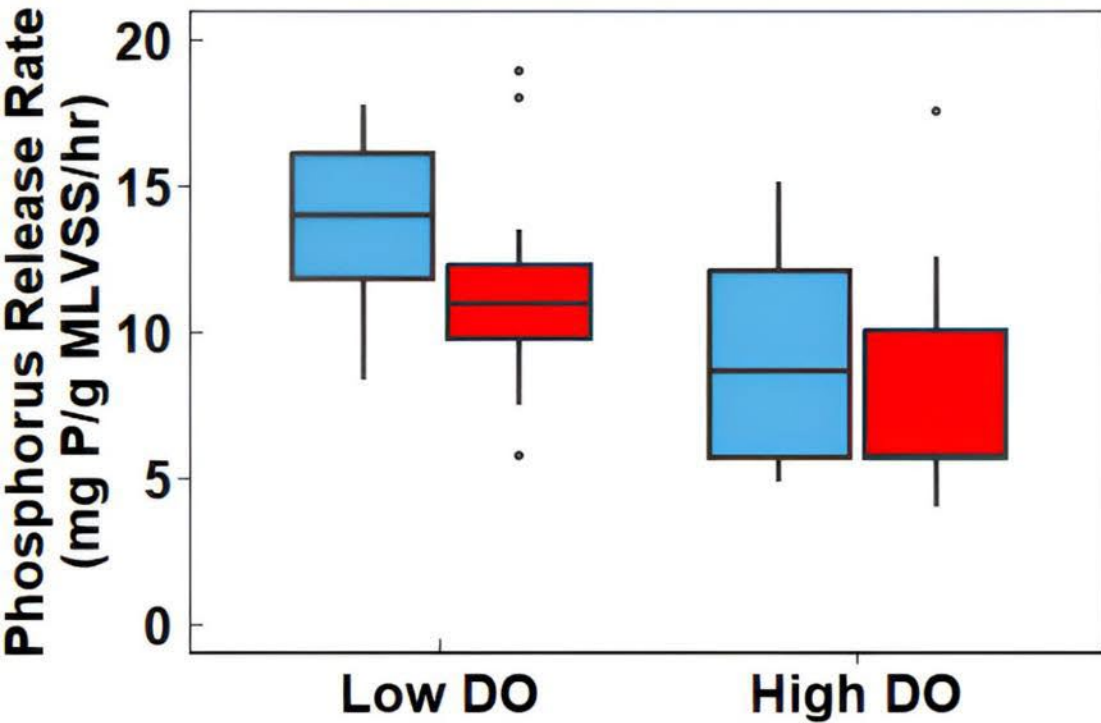

VIP Low DO Pilot Team



2022-2023



2024-2025



2025-2026

VIP Pilot: Average effluent phosphorus concentrations lower at the lowest operating DO (0.2 mg/L)

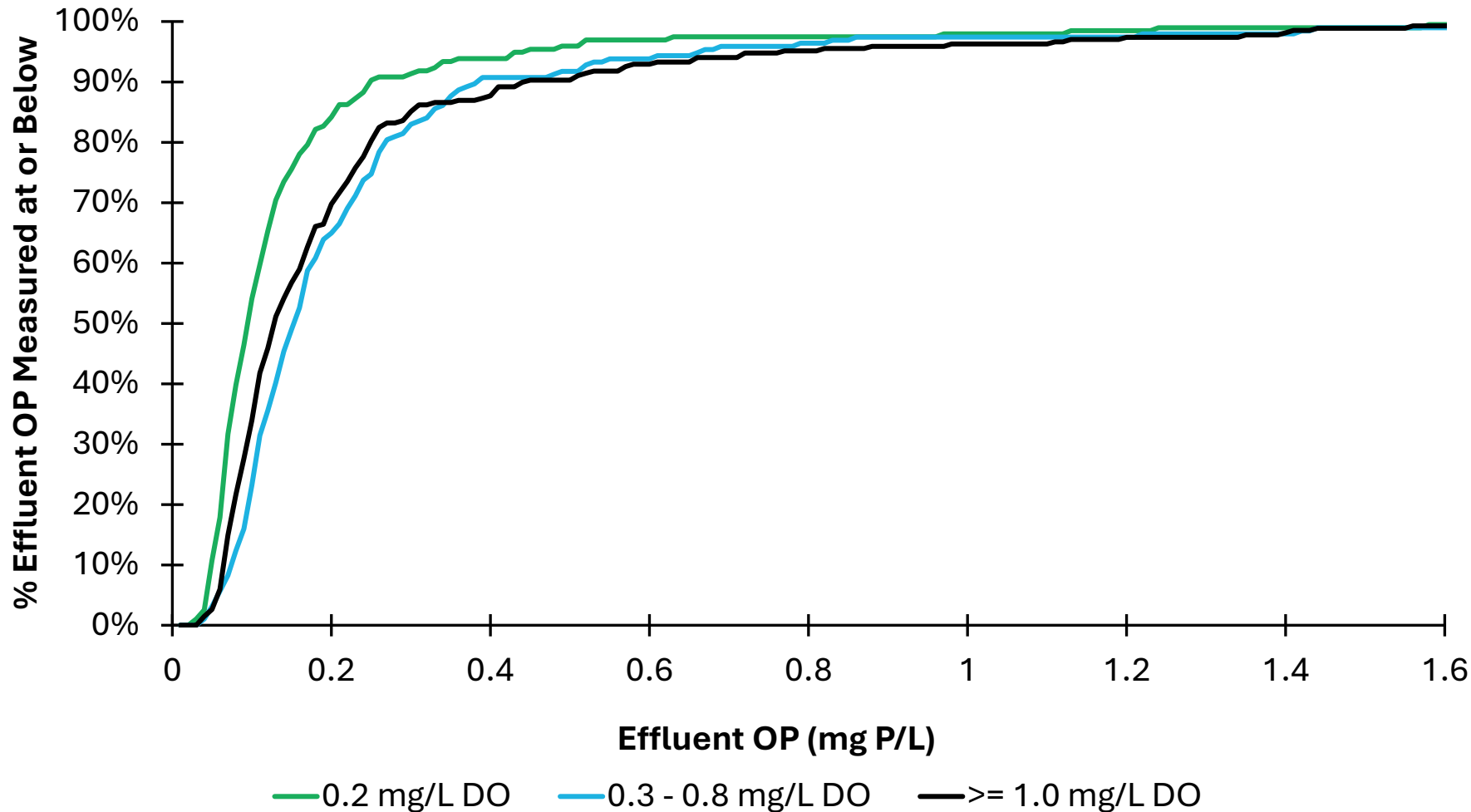

Pilot has shown: PAOs don't really need to adapt to low DO. And high DO seems to be inhibitory...

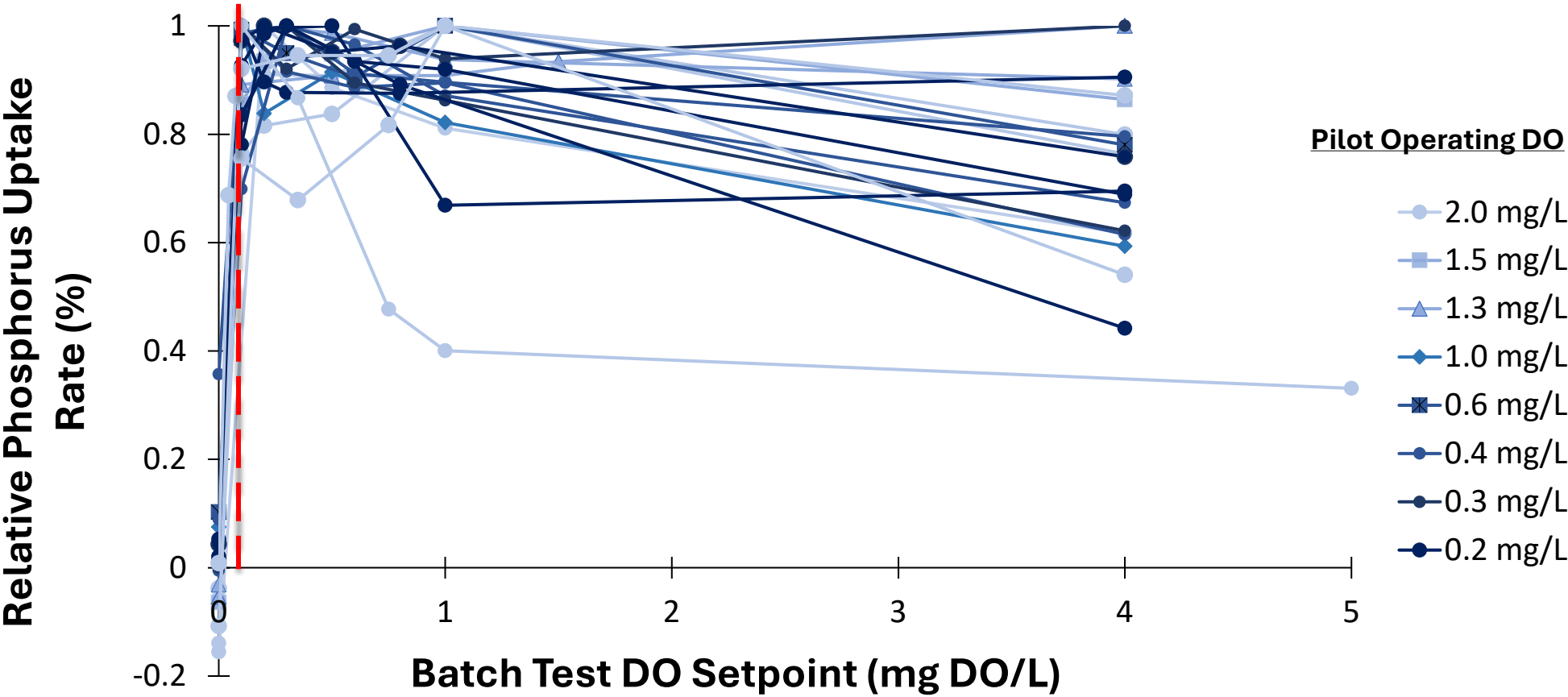

VIP pilot and full-scale observe higher phosphorus uptake rates at low DO

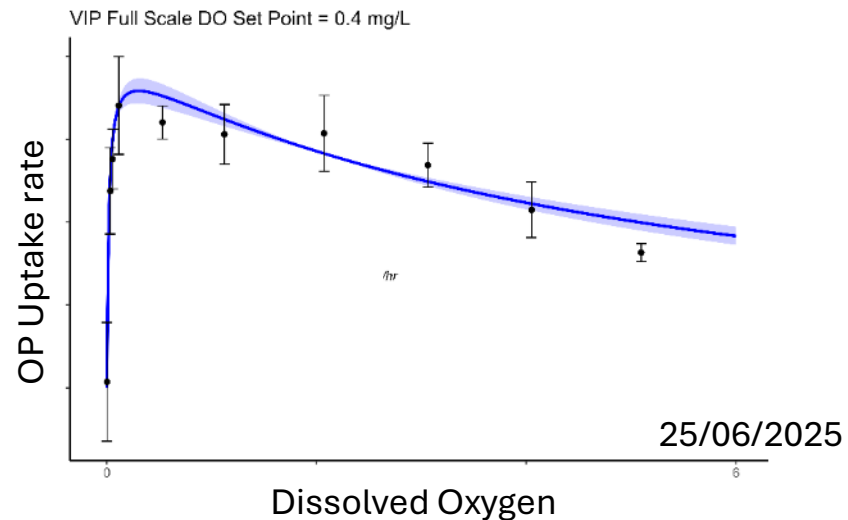
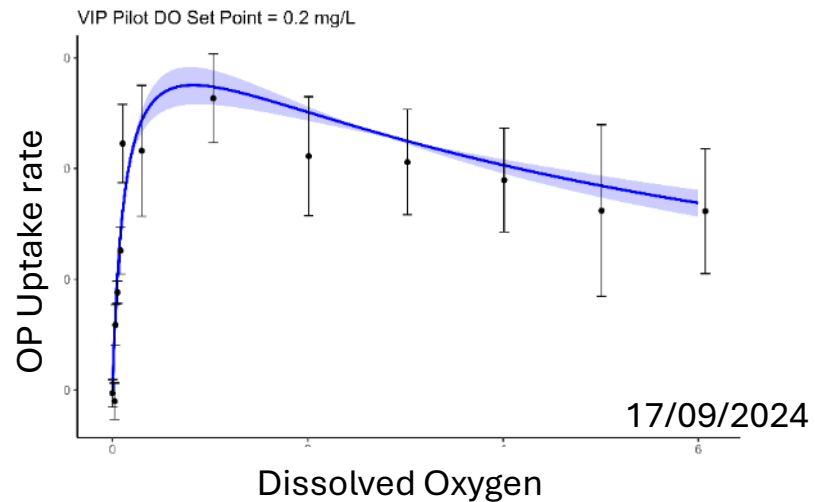
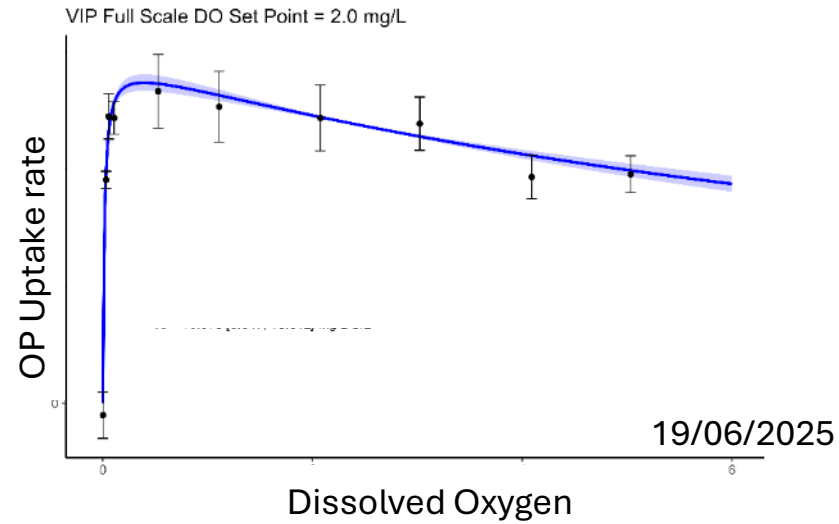
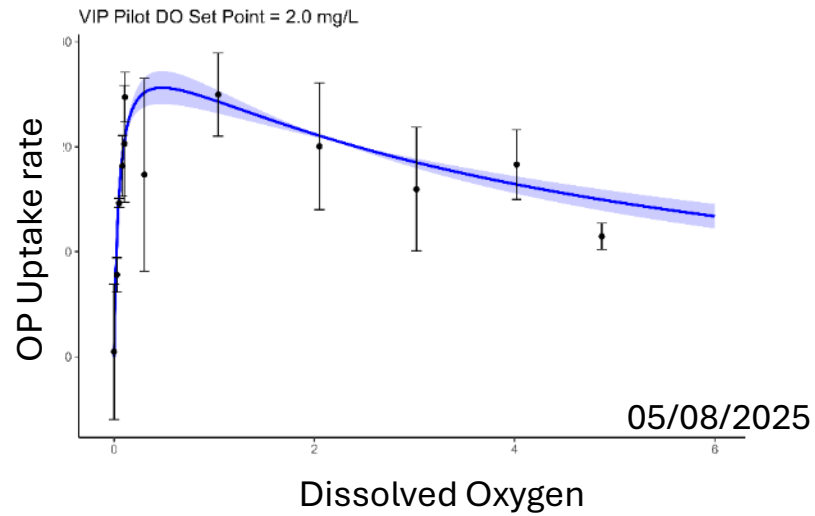

How do we operate consistently at low DO? ABAC and AvN – and we are headed there regardless

VIP full-scale, as an example

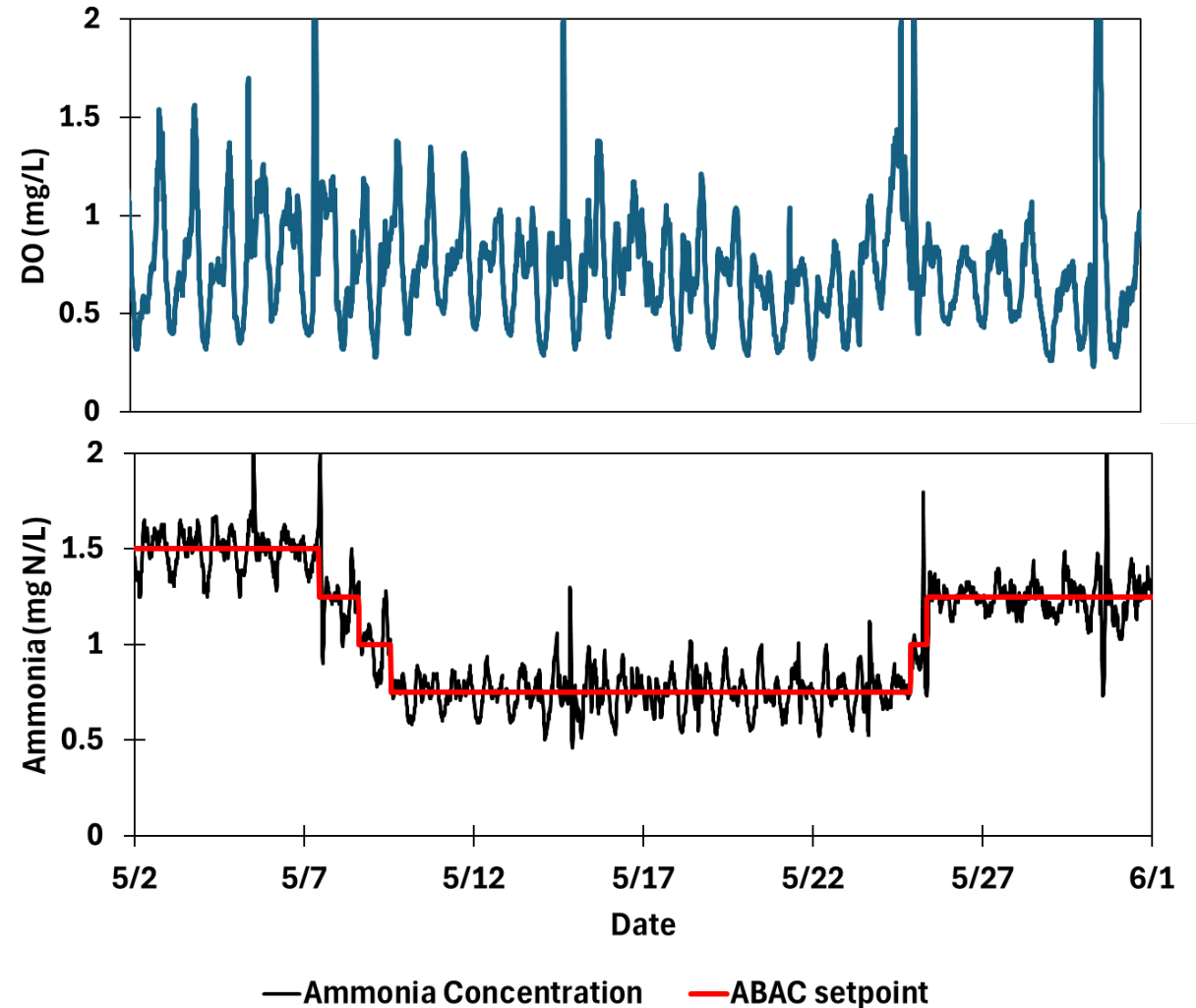
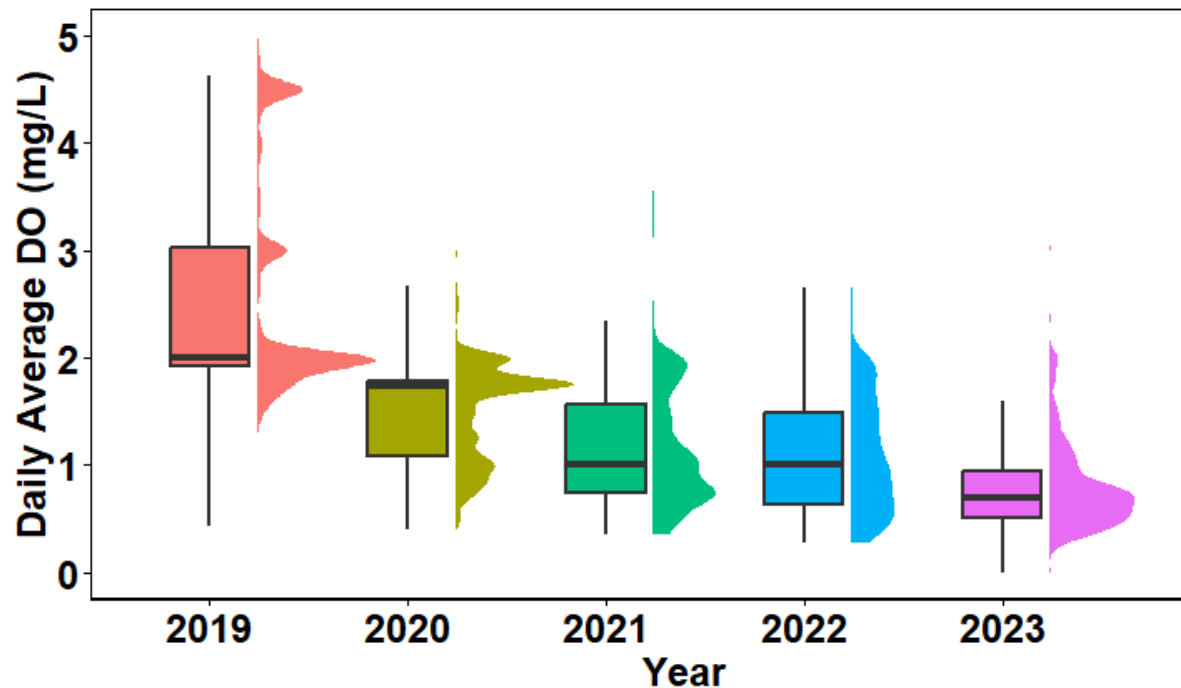

Calcium Carbonate = CaCO_3

- Limestone...
- Crushed to generate a fine powder
- Sparingly soluble, but low pH in aeration tanks drives dissolution
- Can this be used as a source of alkalinity instead of caustic?
 - Caustic soda = sodium hydroxide = NaOH
- Cost = 10X lower than purchased NaOH , even for the fancy powdered product delivered on pneumatic trucks



Pilot CaCO_3 feed system at Army Base provided by Crew Carbon, Inc.

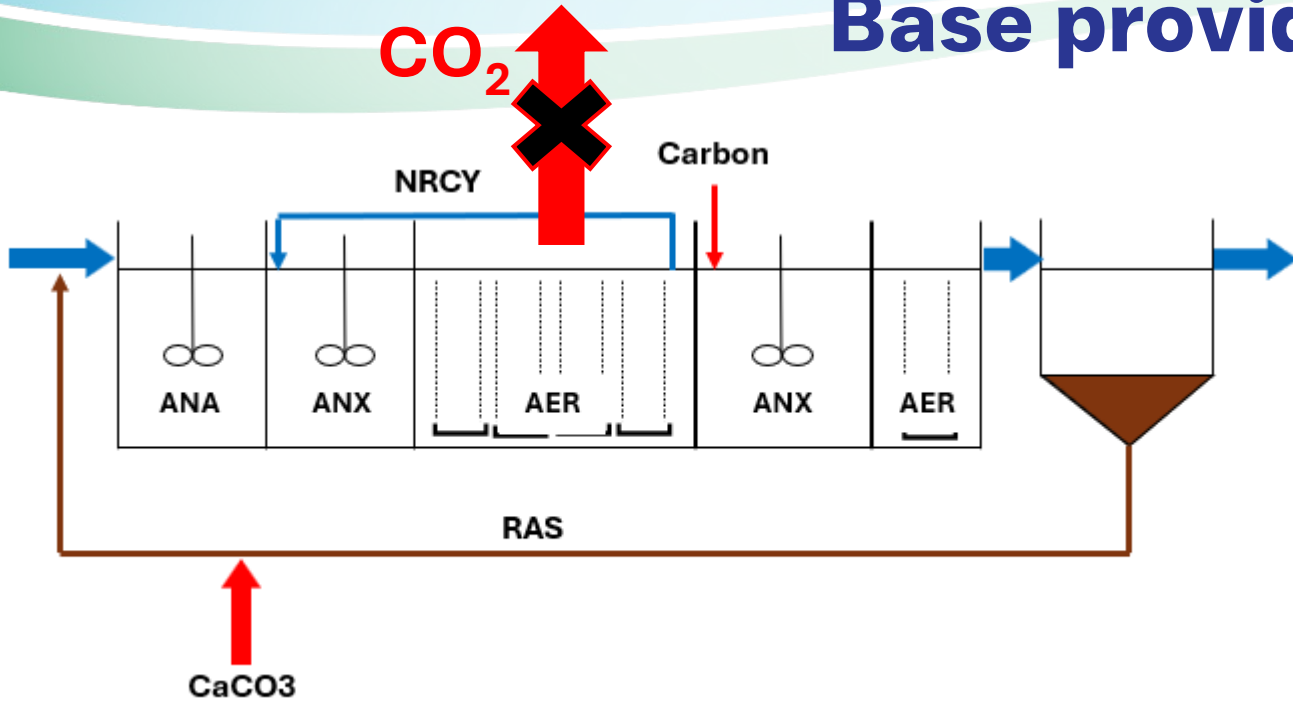

CREW CARBON (“CREW”)

- Isometric Wastewater Alkalinity Enhancement (WAE) protocol approved and ABTP project validated in 2025.
- Data provided by HRSD from ABTP enables CREW to measure and validate carbon credits, and sell them on the voluntary carbon market.
- CREW has secured contracted offtake for WAE through the sale of carbon credits to large corporations.
- Voluntary market is not influenced by federal/local legislation, and demand for carbon credits is growing rapidly.



CREW CARBON



◆◆ **Frontier** **stripe**

JPMORGAN
CHASE & CO.

Google

workday

Watershed

H&M Group

AUTODESK

salesforce

shopify

ABTP CaCO₃ addition from Feb 2025 to Sept 2025

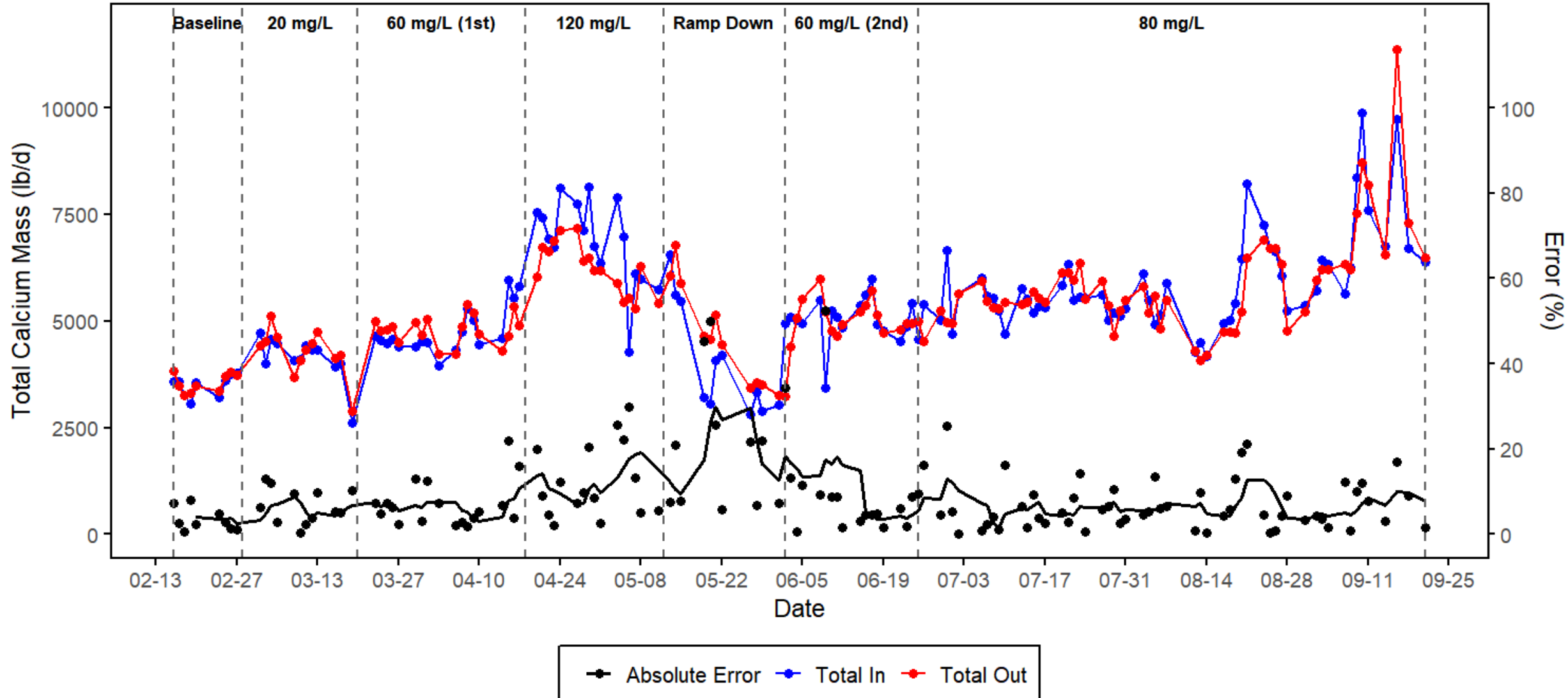

HRSD developed a new IP that combines CaCO_3 with inDENSE

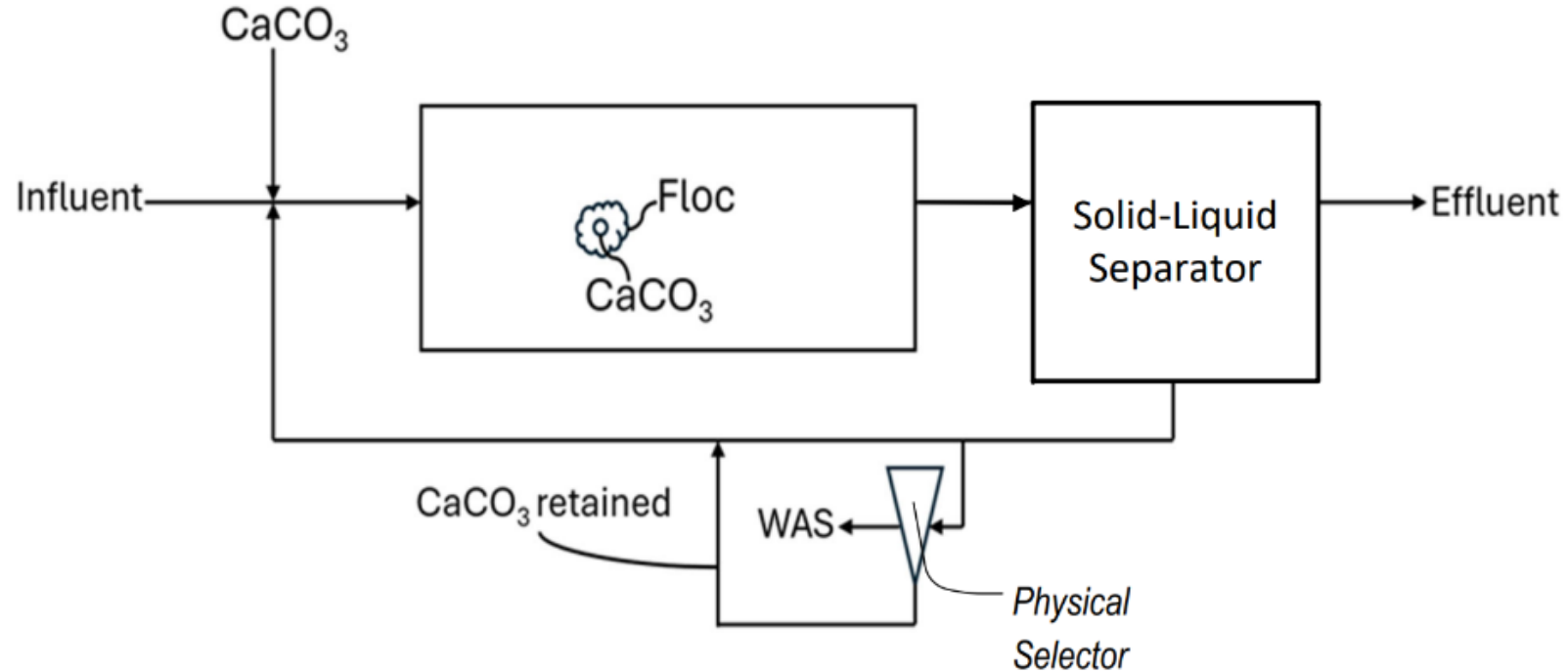

A SYSTEM AND METHOD FOR GRAVIMETRIC SELECTION WITH ADDITION OF MINERALS TO PROVIDE A REDUCTION IN CARBON DIOXIDE EMISSIONS AND OTHER BENEFITS

Implementing Hydrocyclones with CaCO_3 addition

Hypotheses:

- 1) Hydrocyclones will densify biomass and improve settling to deal with Microthrix
- 2) Hydrocyclones will retain CaCO_3 in process, driving more dissolution

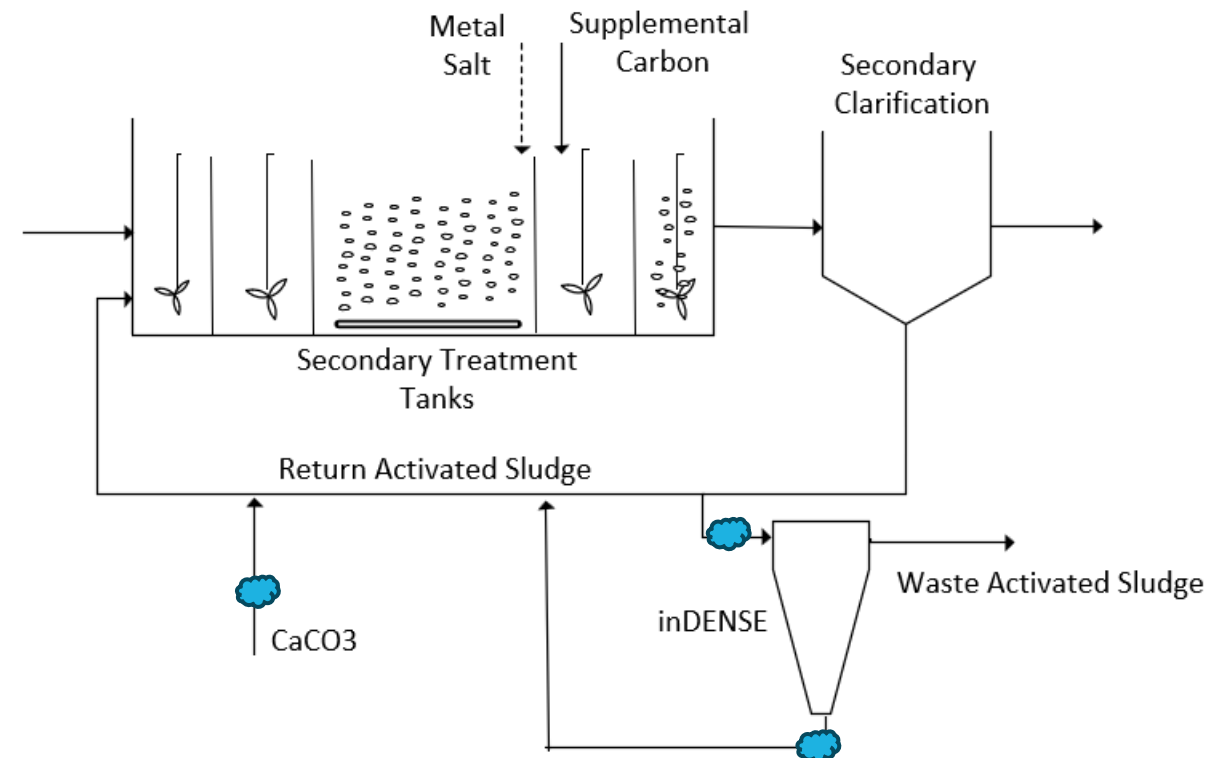
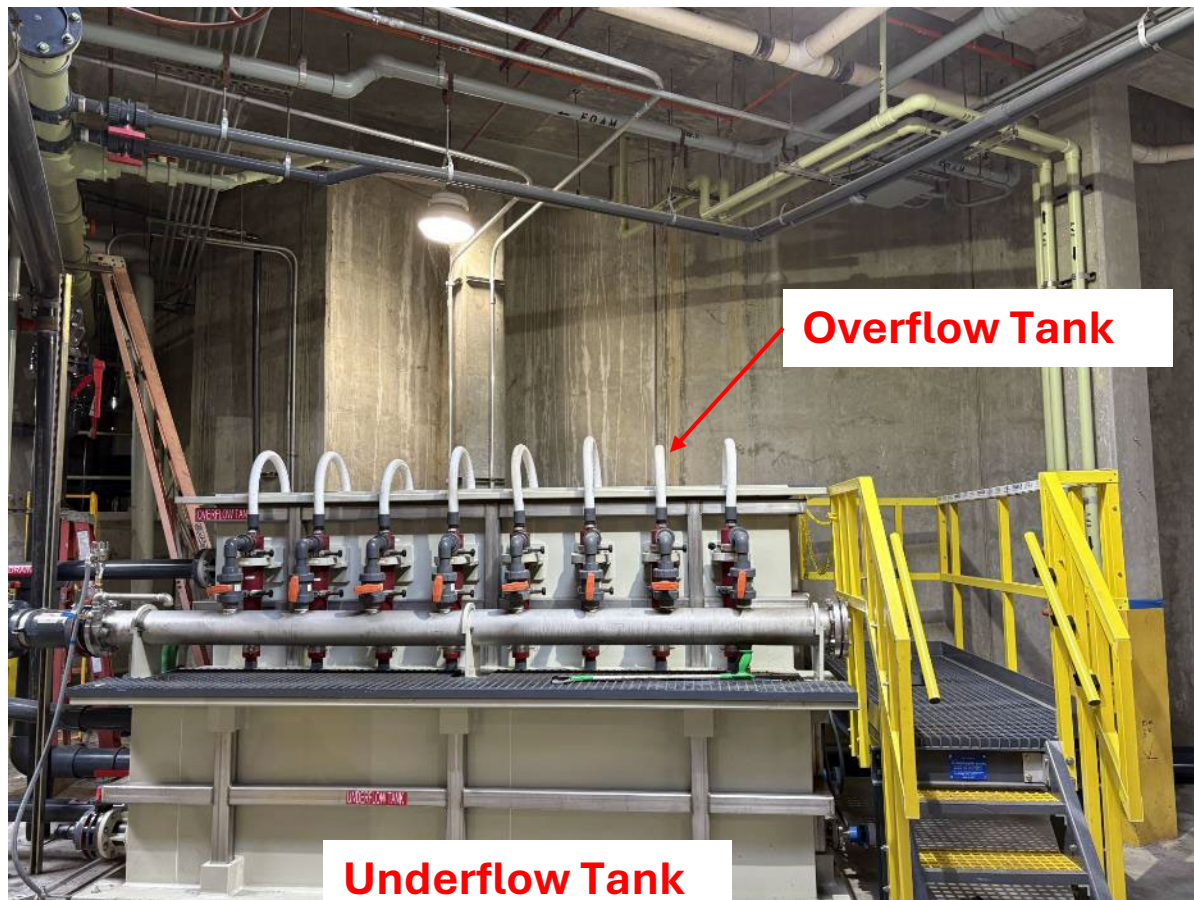

CaCO₃ dissolution increased from ~78 to ~91 percent after inDENSE was implemented = caIDENSE

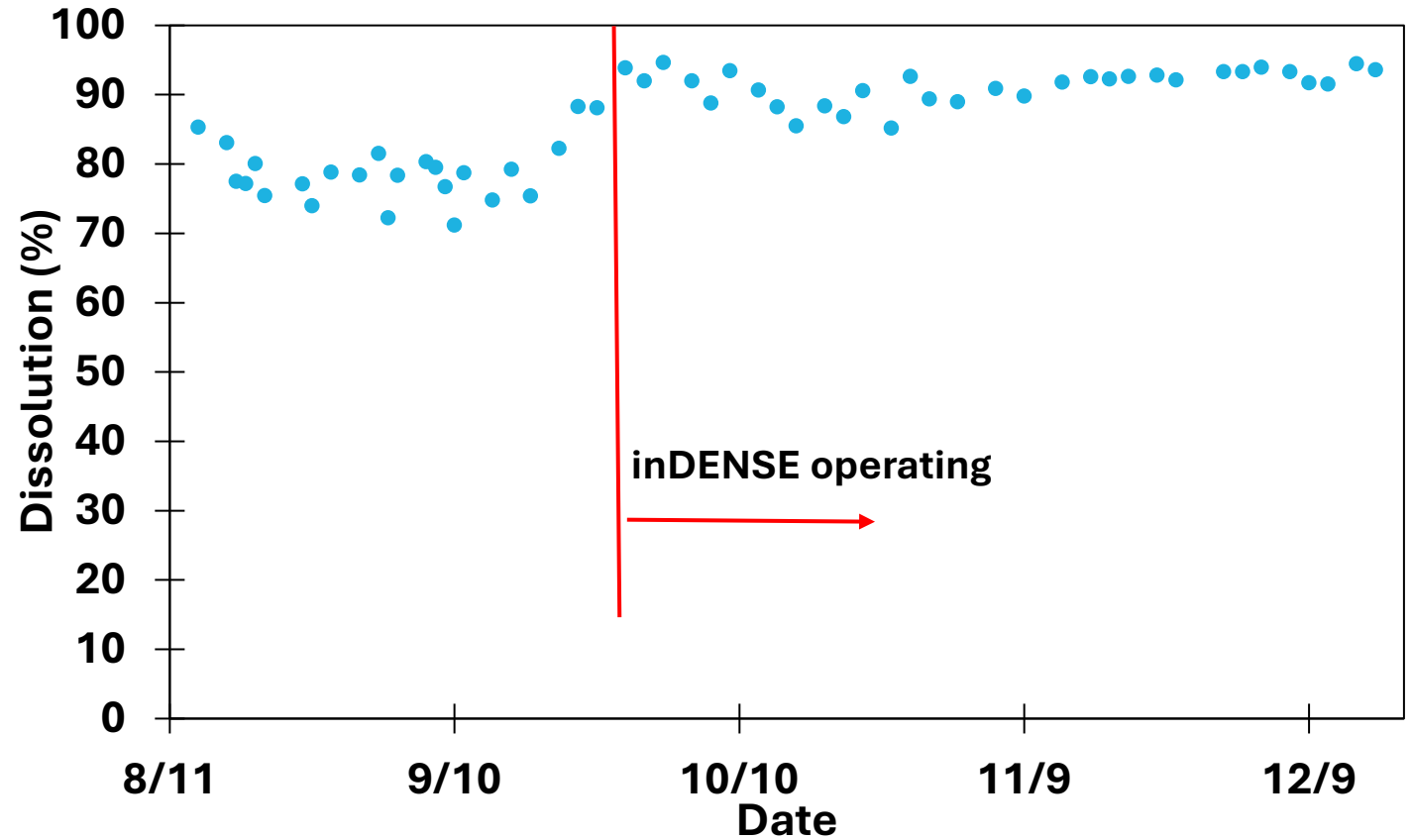

It is very difficult to produce mixed liquor that settles well (SVI) and produces low turbidity effluent...

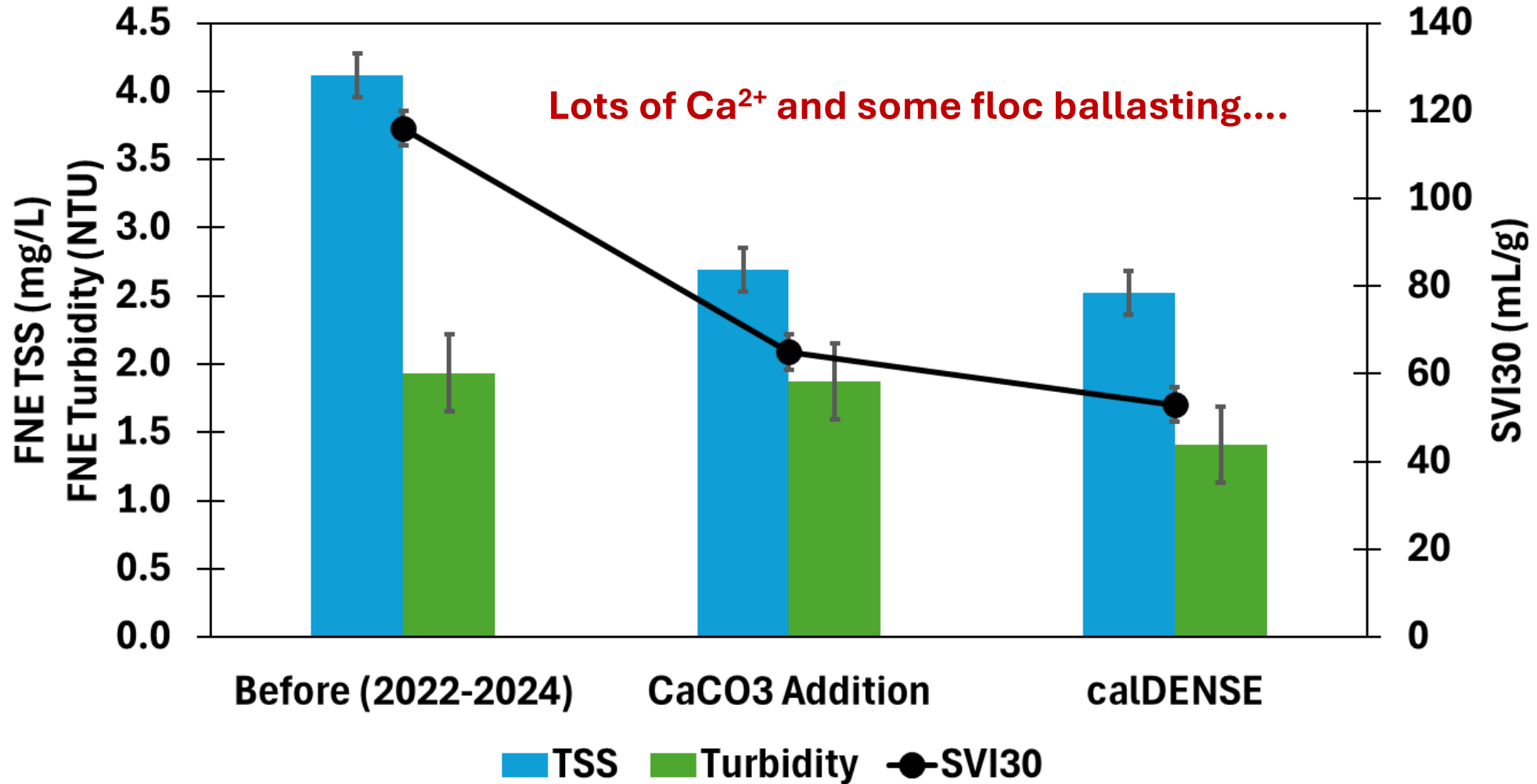

calDENSE has improved BioP at ABTP (and less pP)

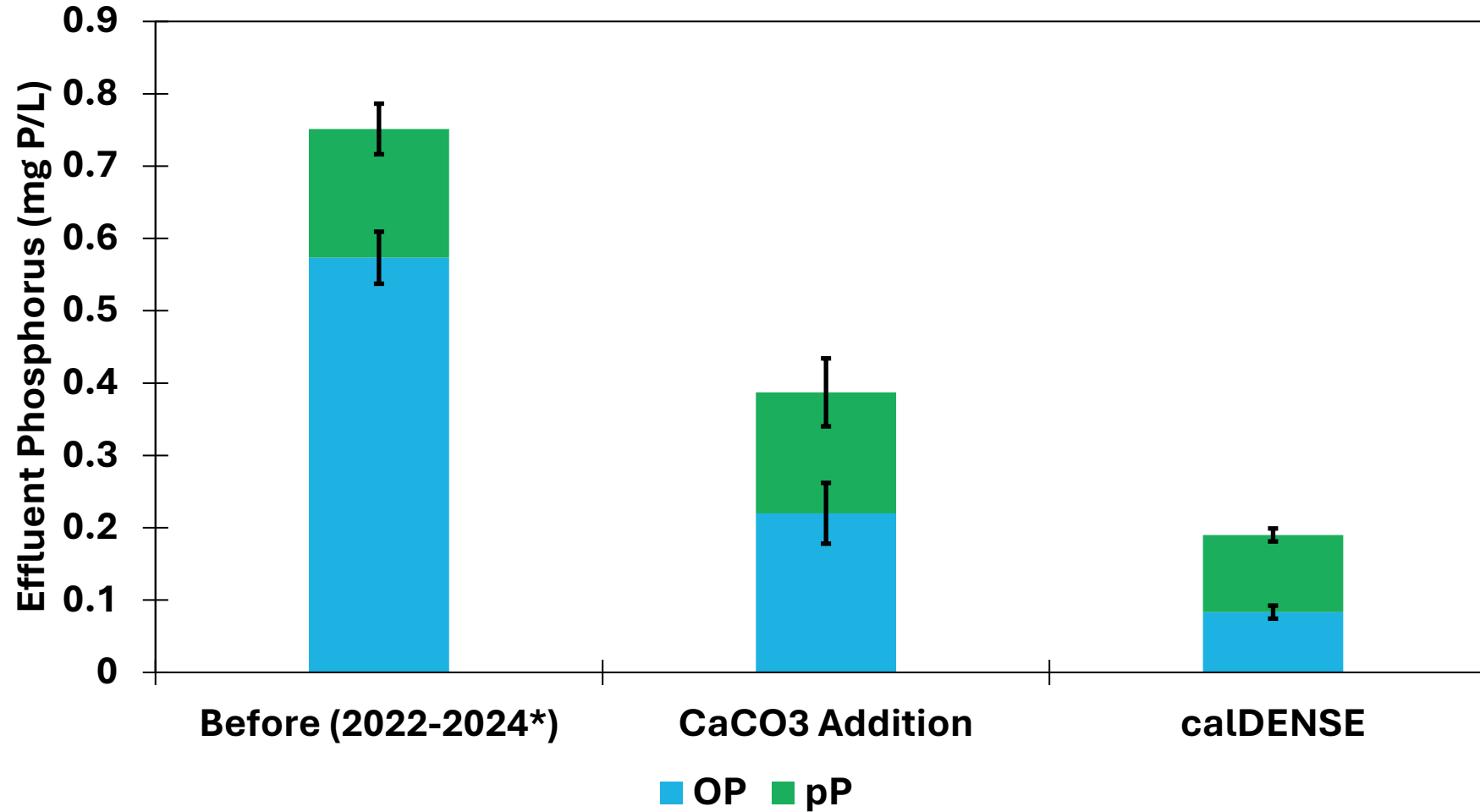

Sept 2024 – Shut down of dewatering and incineration

Permanent CaCO₃ Installation at HRSD VIP Treatment Plant

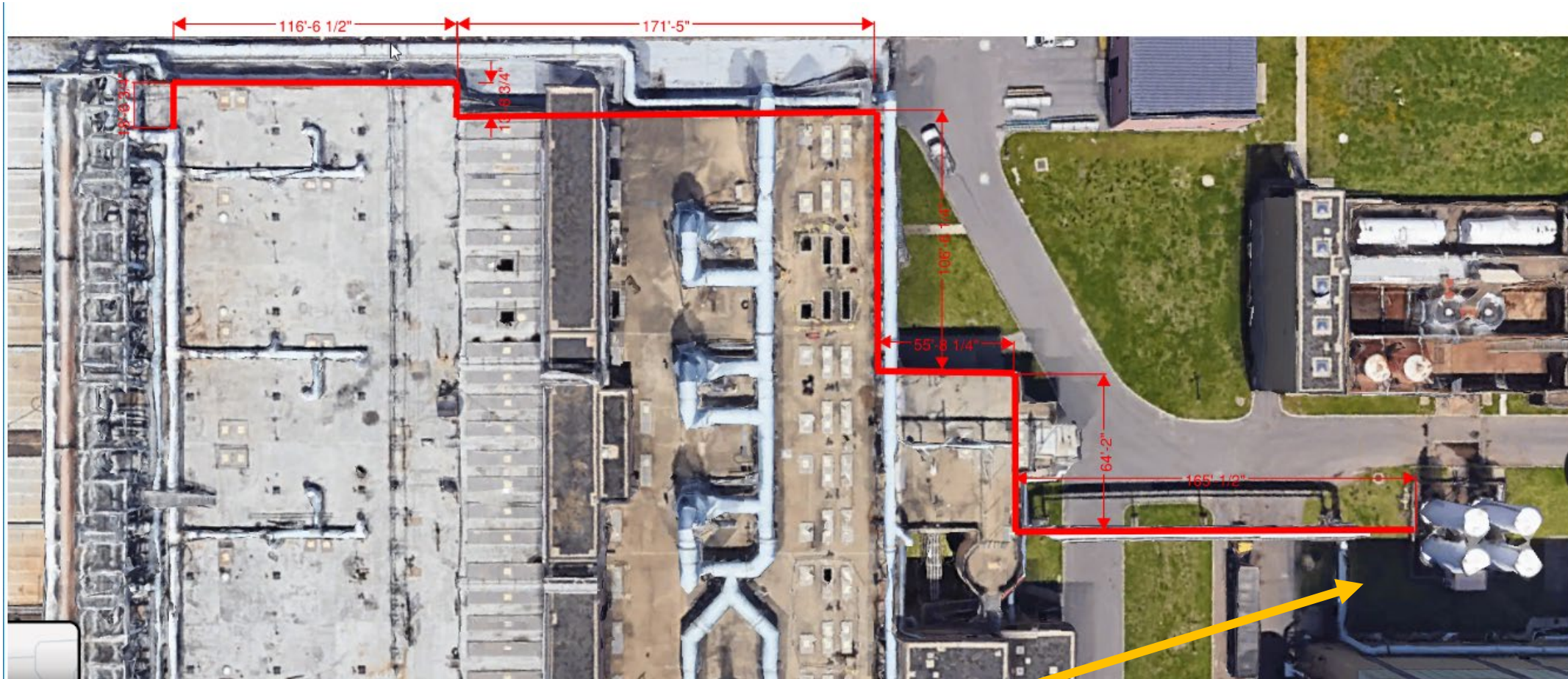

Moving towards caIDENSE at VIP, design with WWWW

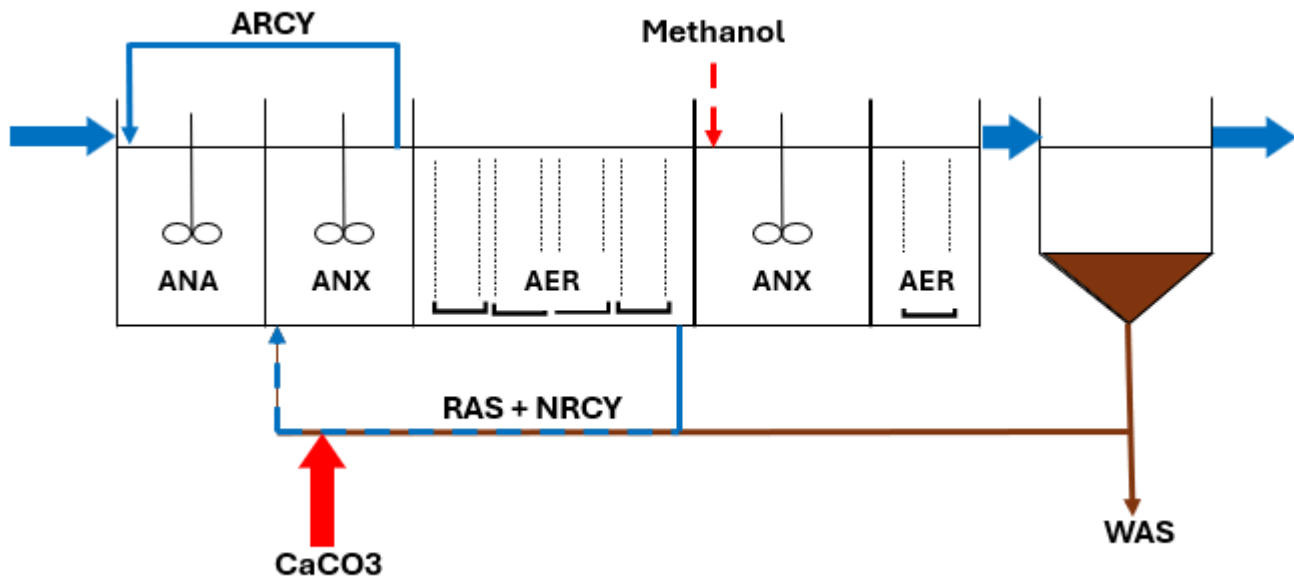
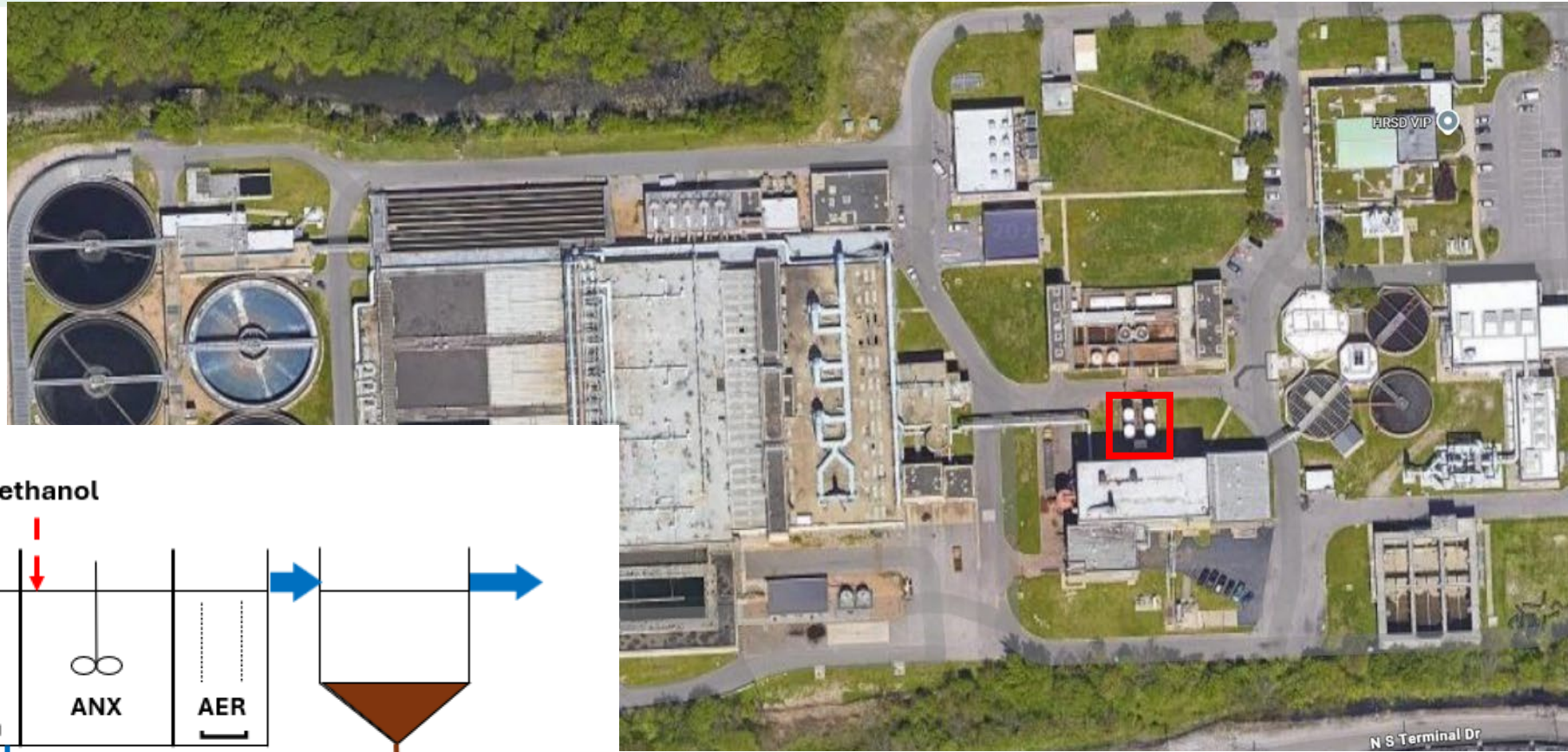

CREW Carbon Agreements – VIP and ABTP

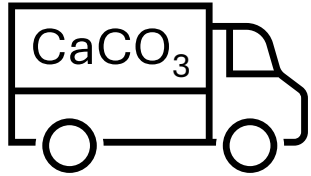
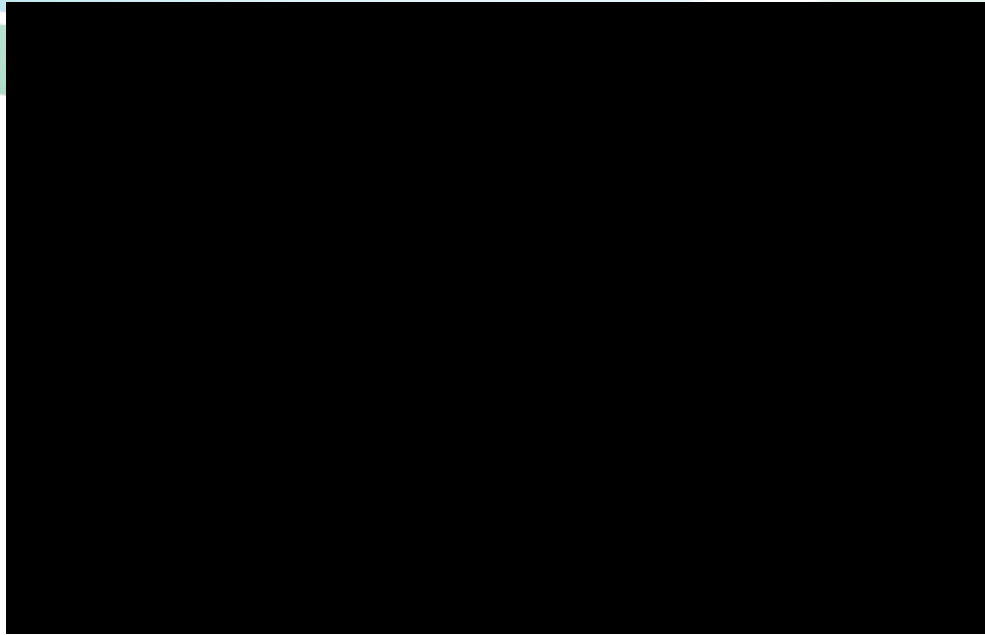

Technology Fee (VIP)
Lease Equipment (AB)

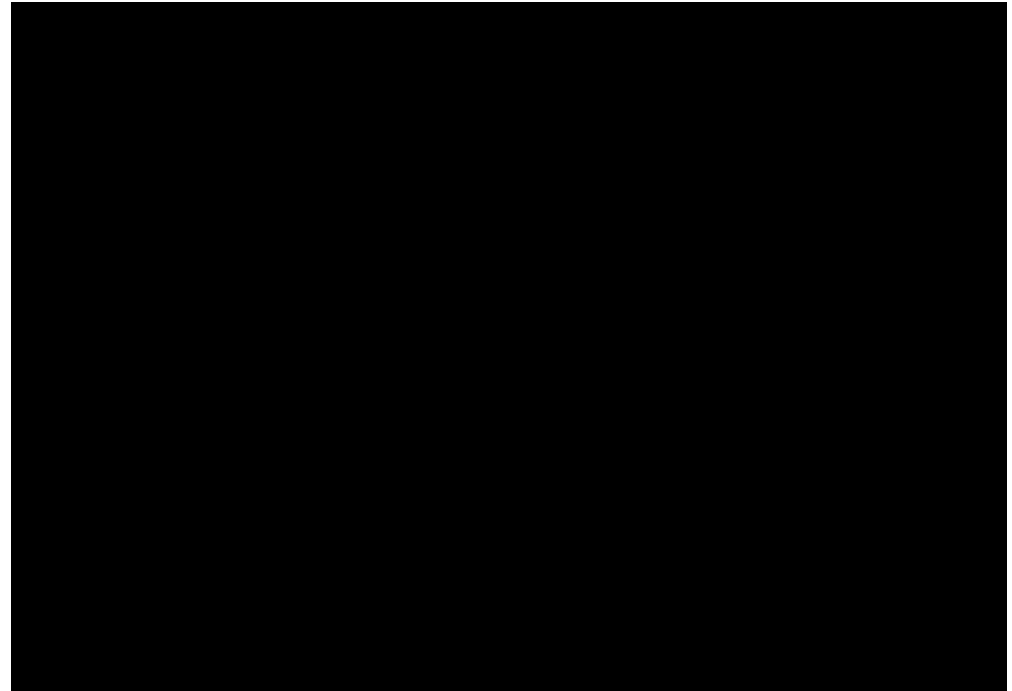
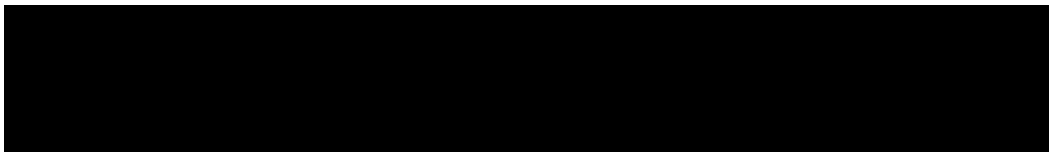

Carbon capture

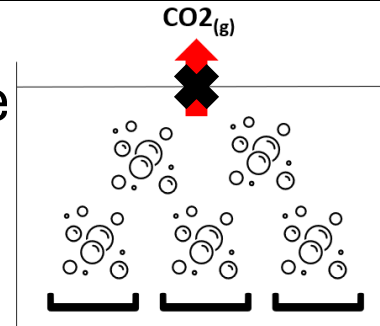

Redacted information, proprietary

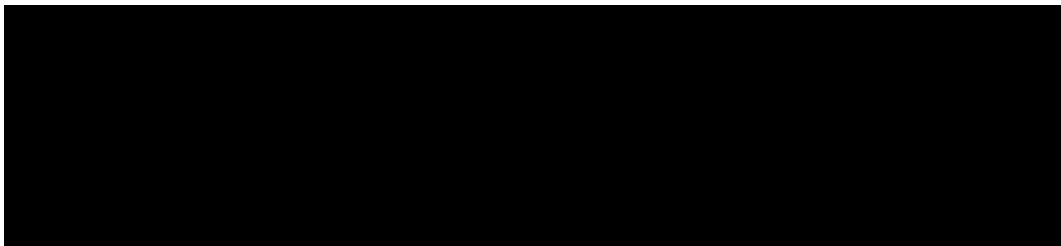

2032 – Modified Plan

Limit = equivalent discharged load = 0.3 mg/L * Treated Flow [lbs TP/year]

Plant	TP (mg/L)	Notes
Army Base	0.3	BioP + CaCO3 and inDENSE (calDENSE)
James River	0.3 65% recharge	BioP , sidestream return load managed with a small dose of alum/ferric, Floc/Sed/Biofilt, SWIFT Recharge
Nansemond	0.3 65% recharge	BioP , sidestream struvite recovery, MgO and WASTRIP, periodic ferric addition, Floc/Sed/Biofilt SWIFT Recharge
VIP	0.3	BioP + CaCO3 and inDENSE (calDENSE)
Williamsburg	0.5	BioP sidestream return load managed with a small dose of alum + ICE stepfeed
Permit compliance	-6.5%	Without SWIFT Recharge
Permit compliance	25.3%	With SWIFT Recharge

VIP ChemP Polishing & Tertiary Filter CIP Project

VIP Tertiary Treatment		Program Cost
GN016390	Preliminary Engineering	\$5.57M
GN016391	Site Work	\$52.9M
GN016392	Tertiary Treatment Upgrade	\$269M

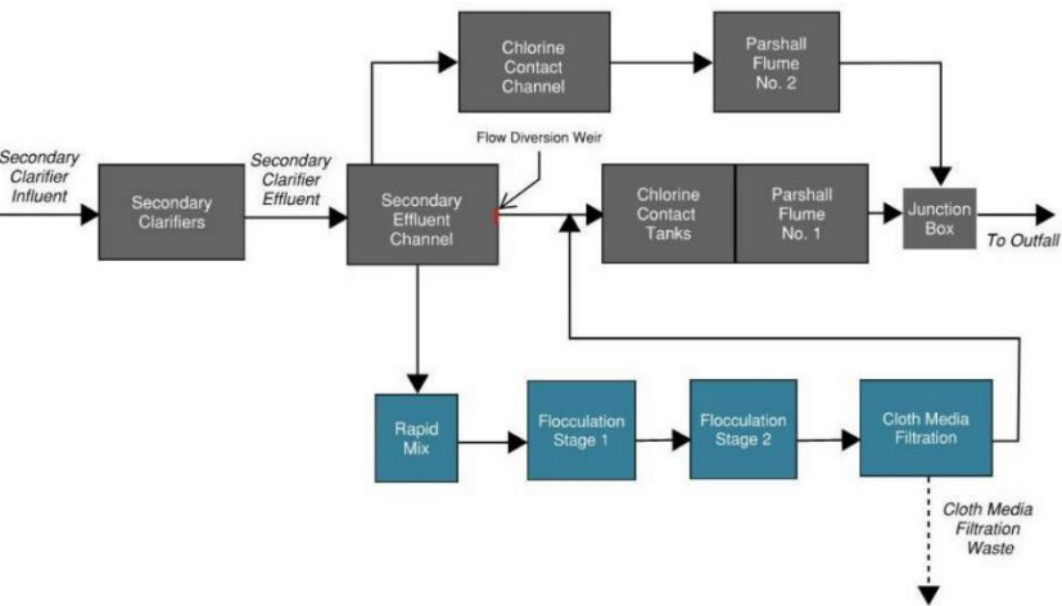

Recommendations

- Approve all three agreements with CREW Carbon, Inc.
 - Data Licensing Agreement for VIP and ABTP
 - System Lease and Chemical Supply Agreement for ABTP
 - Chemical Supply Agreement for VIP
 - Net loss for HRSD of about \$49,000/year for VIP and ABTP, combined
- Approve WWWW equipment purchase for caLDENSE CaCO₃ feed system at VIP \$957,084
 - Design: HRSD staff
 - Construction: HRSD staff & project team and on-call contractors
 - Fund out of operating budget

- Implement CaCO₃ feed system at VIP very quickly
- Test CaCO₃ and bioP performance at VIP starting Aug 2026
- Reconsider the need VIP ChemP polishing and Cloth Media Filtration
- Evaluate sourcing of CaCO₃ powder independent of CREW Carbon Inc.
- Propose several smaller CIP projects at VIP
 - Verification of alum system capacity and capability (not CIP)
 - Eliminate secondary clarifier scum eductors (not CIP)
 - inDENSE (provides formal calDENSE)
 - Convert Nitrification Enhancement Facility to MBBR
 - Modify EQ tank to allow for partial diurnal equalization (cover with odor control and mixing)
 - Convert from VIP to 5-stage Bardenpho (?)
- Install formal calDENSE system at ABTP (remove pilot equipment)
- Consider calDENSE at York River Treatment Plant?

Research Questions Remaining (Riley Doyle's work)

- Validation of carbon capture
- Impact on oxygen transfer and diffuser performance
- Impact on N₂O emissions
- Quantify biological treatment benefits
- Dissolution efficiency
- Stabilization of bioP with seawater infiltration?

Research Questions Remaining (Lily McIntosh's work)

- Why does low DO seem to enhance bioP?
- How does residual ammonia impact nitrifier kinetics and bioP?
- What drives SND at low DO?
- How does low DO impact settleability, caLDENSE benefit?

HRSD's Phosphorus Story: Improving the Performance of Biological Phosphorus Removal

(no PdNA today...)

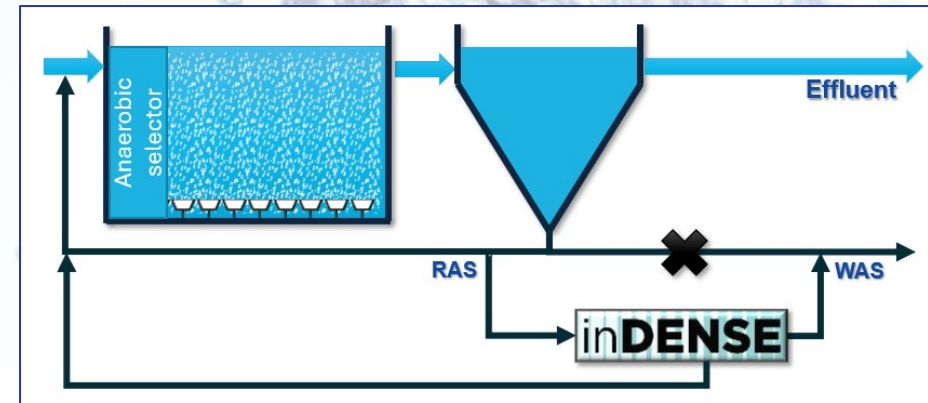
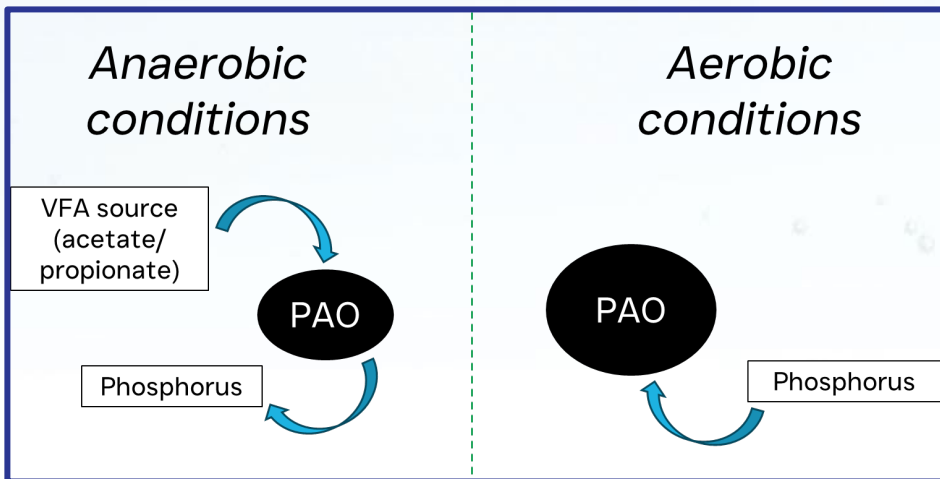

**CREW
CARBON**



HRSD
Sustainable, Innovative Wastewater Treatment



**UNIVERSITÉ
LAVAL**

HRSD Commission Meeting Minutes
January 27, 2026
Attachment #5

8. High Priority Inflow and Infiltration Reduction Program
Locality Agreement with the James City Service Authority

HIGH PRIORITY INFLOW AND INFILTRATION REDUCTION PROGRAM

LOCAL AGREEMENT WITH THE JAMES CITY SERVICE AUTHORITY

This Agreement (“Agreement”) is entered into as of the date of last signature below, by and among the Hampton Roads Sanitation District (“HRSD”) and the James City Service Authority (“JCSA” or the “Locality”) (HRSD and JCSA each a “Party” and together the “Parties”).

Recitals

WHEREAS, the Locality is within the territory of the “District” as defined in 1960 Acts of Assembly, c. 66, as amended (the “Act”), and HRSD provides wastewater transmission and treatment services in the Locality; and

WHEREAS, working closely with the U.S. Environmental Protection Agency, Virginia Department of Environmental Quality, and local communities, HRSD has embarked on an extensive program to reduce sanitary sewer overflows in the District; and

WHEREAS, a critical component of these efforts on behalf of the District and the Locality is the implementation of HRSD’s High Priority Inflow and Infiltration Reduction Program (the “Program”), during which HRSD will conduct extensive efforts including studies, design, and construction on sewer systems in the District owned and operated by various localities, governmental authorities, and private property owners, including the Locality; and

WHEREAS, JCSA owns and operates a sanitary sewer collection system (the “Locality System”) that collects sewage in James City County and delivers it to HRSD’s “sewerage system,” as defined in the Act, for conveyance and treatment; and

WHEREAS, to address regional wet weather sewer capacity requirements, HRSD and the Locality, along with other jurisdictions, have been involved in a process to develop and implement a Regional Wet Weather Management Plan (“RWWMP”); and

WHEREAS, as a result, a Memorandum of Agreement, attached and incorporated herein as Exhibit A (the “MOA”), was developed through a cooperative process with HRSD and 14 local governments, including the Locality; and

WHEREAS, HRSD selected the Public-Private Education Facilities and Infrastructure Act of 2002 (Virginia Code § 56-575.1. *et seq.*) (the “PPEA”) as its method for developing and contracting for the implementation of the Program in furtherance of the RWWMP and the MOA; and

WHEREAS, following the review and analysis of proposals, HRSD selected Burns & McDonnell Engineering Company, Inc. (the “Design-Builder”) for the planning, design, and construction of the Program; and

WHEREAS, HRSD entered into an interim agreement with the Design-Builder pursuant to Virginia Code § 56-575.9:1, which was approved by the Hampton Roads Sanitation District Commission (the “Commission”) on August 27, 2024, and amended in March 2025 and June 2025 (collectively, the “Interim Agreement”); and

WHEREAS, HRSD and the Commission determined that the Program serves the public purpose of the PPEA under the criteria set forth in Virginia Code § 56-575.4(C); and

WHEREAS, on September 23, 2025 the Commission approved a comprehensive agreement with the Design-Builder pursuant to Virginia Code § 56-575.9 (the “Comprehensive Agreement”), which allows for the development and operation of phases and segments of the Program through HRSD’s approval of specific projects and corresponding scopes of work (each a “Project Package,” used herein as defined in the Comprehensive Agreement); and

WHEREAS, as part of the Interim Agreement, the Design-Builder produced a Comprehensive I/I Reduction Program Plan, which was incorporated into the Comprehensive Agreement and anticipates that work will be performed under Project Packages within the Locality, possibly including, but not limited to, engineering, planning and design, procurement of materials and equipment, construction, testing, and commissioning of all elements necessary to rehabilitate and replace portions of the Locality System; and

WHEREAS, HRSD expects Design-Builder to perform work in the Locality related to the Locality System; and

WHEREAS, the bonds, insurance, warranty, and guarantees required of the Design-Builder by the Comprehensive Agreement apply to the work to be performed on the Locality System; and

WHEREAS, HRSD and the Locality agree that it is consistent with the MOA and in the best interests of the Parties to have such improvements to the Locality System constructed and paid for by HRSD as part of its work with Design-Builder for the design and construction of the Program, under the terms and conditions of the Comprehensive Agreement, the MOA, and those set forth herein.

NOW, THEREFORE, in consideration of the above recitals, which are incorporated herein by reference, the agreements set forth below, HRSD’s investment in the Program within the Locality and improvement of the Locality System, and other good and valuable

consideration, the receipt and sufficiency of which is hereby acknowledged, the Parties agree as follows:

I. SUPPLEMENTATION OF THE MOA. This Agreement supplements and clarifies the understanding of the Parties as to certain provisions of the MOA as they relate to the Program generally, and the Project Packages being constructed in the Locality, but does not replace the MOA in its entirety. Where there is a conflict between the terms of this Agreement and the MOA, the terms of this Agreement shall control.

II. DESIGN AND CONSTRUCTION OF IMPROVEMENTS. HRSD will design and construct improvements to sanitary sewer infrastructure in the Locality, including the Locality System, to be described in Project Packages approved by HRSD (such work being the “Improvements”). Each portion of the Locality System and associated real property necessary for completion of the Improvements is referred to herein as a “Site.” The Parties agree that the Improvements will be designed and constructed pursuant to the Comprehensive Agreement and in accordance with the following:

A. Design of Improvements

1. HRSD and the Design-Builder will prepare Project Packages, including the Improvements in accordance with the Comprehensive Agreement.
2. The Locality will have an opportunity to review and comment on the draft final preliminary engineering report (“PER”) provided by the Design-Builder related to the Improvements proposed to the Locality System. The Locality shall promptly, but no later than fourteen (14) days after the PER is provided by HRSD (the “Initial Comment Period”), provide any comments or proposed revisions to the PER in writing to HRSD. The Parties agree that the Initial Comment Period is the Locality’s opportunity to consult and coordinate in the preliminary and detailed design of the Improvements related to the following:
 - a) The Design-Builder’s preliminary project schedule, including projected timelines for work being performed on the Locality System.
 - b) The list of applicable Hampton Roads Planning District Commission (“HRPDC”) and HRSD design and construction standards, and identification of JCSA-specific special provisions, amendments, modifications, or additional requirements that supersede or supplement the HRPDC standards for design and construction requirements (collectively referred to as “Special Provisions”). As of

the date of the Agreement, JCSA has identified the following Special Provisions: JCSA's Design & Acceptance Criteria, which include but are in no way limited to JCSA's HRPDC Special Provision, MH & Wet Well Contract Specifications, Trenchless Rehabilitation Specifications, Flextran Interceptor Rehabilitation "Large Lining Contracts" Specifications, JCSA Asphalt Repair Specifications. The Parties acknowledge that any applicable Special Provisions will be identified by JCSA during the Initial Comment Period for the Improvements identified on the PER.

c) Locality requests contemplated by the MOA.

If no written comments are received from the Locality during the Initial Comment Period, the PER shall be considered approved by the Locality and HRSD and the Design-Builder will proceed with detailed design of the Improvements using the proposed scope of work and design and construction standards.

3. If no written comments are received from the Locality, or once the Locality's written comments are satisfied as mutually agreed by the Parties, HRSD and the Design-Builder will use the PER to prepare a set of draft final plans and specifications for the Improvements that will be governed by a Project Package (the "Draft Final Plans and Specifications").
4. Locality will have an opportunity to review and comment on the Draft Final Plans and Specifications provided by the Design-Builder related to the Improvements proposed to the Locality System. Locality shall promptly, but no later than fourteen (14) days after the Draft Final Plans and Specifications are provided by HRSD (the "Final Comment Period"), provide any comments or proposed revisions in writing to HRSD. If no written comments are received from the Locality during the Final Comment Period, the Draft Final Plans and Specifications shall be considered approved by the Locality and HRSD and the Design-Builder will proceed with completion of the detailed design of the Improvements using the PER and Draft Final Plans and Specifications.
5. If no written comments are received from the Locality, or once the Locality's written comments are satisfied as mutually agreed by the Parties, HRSD and the Design-Builder will use the Draft Final Plans and Specifications to prepare a set of final plans and specifications for the Improvements that will be governed by a Project Package (the "Final Plans and Specifications").

6. Locality will have an opportunity to review and approve any “or-equal” or product substitutions proposed by HRSD or Design-Builder for Improvements to the Locality System that vary from the design and construction standards identified in the PER. Locality shall promptly, but no later than fourteen (14) days after receiving notice of the proposed substitution, provide approval or other comments in writing to HRSD. If no written comments are received from the Locality within such fourteen (14) day period, the proposed substitutions will be considered approved and HRSD and the Design-Builder will proceed with detailed design and construction of the Improvements using the proposed substitutions.
7. All Final Plans and Specifications shall comply with the PER unless otherwise approved by the Parties.

B. Construction of the Improvements.

1. HRSD and the Design-Builder shall be responsible for constructing the Improvements in substantial conformance with the Final Plans and Specifications.
2. The Locality will be included as an additional insured on the applicable policies of insurance required by the Comprehensive Agreement for each Project Package involving construction of Improvements to the Locality System.
3. HRSD and the Design-Builder shall be responsible for preparing, finalizing, and executing any and all front-end documents, construction contracts, architectural contracts, engineering contracts, drawings, surveys, bidding documents, bonds, insurance documents, construction plans, and all amendments, revisions and modifications thereto, relating to the construction of the Improvements (collectively, the “Project Documents”).
4. The Parties understand and agree that construction of the Improvements, or any portion thereof, may be abandoned by HRSD if, in HRSD’s sole discretion, the work is no longer expected to be cost-effective for the reduction of inflow and infiltration and sanitary sewer overflows. If a portion of the Improvements are abandoned during administration of a Project Package, HRSD will use commercially reasonable efforts to leave the Site and any areas of disturbance related to the Improvements in no worse condition than existed prior to commencing construction of the portion of the Improvements subject to abandonment, and any non-abandoned portion of

the Improvements to the Locality System will remain subject to the substantial completion and final completion procedures identified in Section IV.I of this Agreement.

5. HRSD expects that the Design-Builder shall serve as the engineer and contractor for the construction of the Improvements. The Design-Builder, and any subcontractors or replacements therefore, shall meet all stated requirements associated with the Project Documents.
6. HRSD and the Design-Builder shall be responsible for all necessary permits and approvals necessary for the construction of the Improvements.
7. HRSD shall arrange and conduct regular progress meetings with the Locality during the construction of the Improvements.
8. HRSD will provide the Locality with notice of the following related to construction of the Improvements to the Locality System:
 - a) The commencement of construction activities on a Site related to the Improvements.
 - b) When a sewer segment is bypassed and when the segment is put back into service.
 - c) When Improvements or a portion thereof will be abandoned as not cost-effective. Such notice will include the steps HRSD or the Design-Builder will take to comply with Section II.B.4 of this Agreement.
 - d) Design-Builder's request for issuance of a certification of substantial completion for the Improvements.
 - e) When a certification of substantial completion is issued by HRSD for the Improvements.
 - f) Design-Builder's request for issuance of a certification of final completion for the Improvements.
 - g) When a certification of final completion is issued by HRSD for the Improvements.
9. HRSD will require the Design-Builder to provide a performance and payment bond for the full amount of the construction of the Improvements.
10. HRSD will use commercially reasonable efforts to have the Design-Builder correct any defects and make any repairs covered by the Design-Builder's warranty of the Improvements or the Design-Builder's applicable policies of

insurance that are reported to HRSD by the Locality within one (1) year of the substantial completion of the Improvements.

11. After the Improvements achieve final completion, HRSD will provide the Locality with the record drawings approved by HRSD. Such approved record drawings will be provided to the Locality within thirty (30) days of being received from the Design-Builder.

12. Upon request by the Locality, HRSD will provide other records and data produced by the Design-Builder during the construction of the Improvements to the Locality System: e.g., pre-construction condition assessment closed-circuit television (CCTV) videos and manhole inspection data, GIS map changes, and post-construction CCTV videos.

III. ACCESS TO THE SITE / RIGHT OF ENTRY

A. HRSD, the Design-Builder, and their authorized subcontractors and agents shall have a license for ingress and egress over the property and easements of the Locality whereon the Improvements are being made and any related infrastructure is located, as well as any other adjacent land owned by, under the control of, accessible by, or within an easement benefiting the Locality, as necessary to access, construct, and maintain the Site or the Improvements, including but not limited to all sewer service laterals and sewer clean-outs, for the purpose of inspecting and reviewing the same, and satisfying HRSD's obligations under this Agreement, the MOA, and the Comprehensive Agreement.

B. Within thirty (30) days of final execution of this Agreement, the Locality will provide HRSD and the Design-Builder with a letter or other written authorization for presentation to landowners and Locality personnel memorializing HRSD and the Design-Builder's ability to use the Site and the Locality's real property and easements to design and construct the Improvements. The Parties agree to execute such further documentation or instruments as are necessary to confirm, effect, and memorialize the right for HRSD, the Design-Builder, and their authorized subcontractors and agents to access the Locality System, the Site, and related real property and easements necessary to complete the Improvements.

IV. LOCALITY RESPONSIBILITIES. In addition to the obligations described in the MOA and elsewhere in this Agreement, the Locality is responsible for the following to support the MOA, the RWWMP, the Program, and the Improvements:

- A. Coordination with HRSD and the Design-Builder on all of the Locality's projects being conducted on, or in the area of, the infrastructure that is the subject of the Improvements.
- B. Support and facilitation of HRSD's acquisition of any right-of-entry agreements or easements necessary for HRSD and Design-Builder to access and occupy private property to complete the Improvements.
- C. Participation in predesign meetings with HRSD, the Design-Builder, and subcontractors prior to commencement of detailed design work on the Improvements.
- D. Participation in preconstruction meetings with HRSD, the Design-Builder, and subcontractors prior to commencement of construction field work on the Improvements.
- E. Prompt review of any administrative permits required by the Locality for construction of the Improvements. The Parties' expectation is that complete applications for permits related to the Improvements will receive action from the Locality within fourteen (14) days of submission or resubmission.
- F. When necessary, prompt review of traffic control plans related to the Improvements being performed on infrastructure located in or adjacent to rights-of-way. The Parties' expectation is that complete traffic control plans related to the Improvements will receive action from the Locality within fourteen (14) days of submission or resubmission, whether related to rights-of-way regulated by the Locality, the Virginia Department of Transportation, or others.
- G. Prompt notification of any public inquires, complaints/311 calls, or claims received by the Locality related to construction of the Improvements, but in all cases within three (3) business days of the Locality's receipt.
- H. Prompt communication of any concerns raised during observation of the construction work as it is being performed, but in all cases within twenty-four (24) hours after observation.
- I. Participation in HRSD's process for certification of substantial completion and final completion for the Improvements to the Locality System. The Parties' expectation for prompt participation in these processes are as follows:

1. Substantial Completion. Upon receiving notice from HRSD of Design-Builder's request for issuance of a certification of substantial completion for the Improvements, the Locality may inspect the Improvements or review relevant records (collectively "Review") to confirm that the Improvements are constructed and connected to the Locality System in substantial conformance with the Final Plans and Specifications. Within ten (10) days of HRSD's delivery of such notice and relevant post-construction inspection records submitted by Design-Builder, the Locality will notify HRSD whether it elects to Review the Improvements. If the Locality elects to Review the Improvements, the Locality will either (i) provide written notice of satisfaction, or (ii) provide written comments identifying all corrections and modifications that the Locality deems necessary for the Improvements to substantially conform to the Final Plans and Specifications (the "Punch List"). If the Locality elects to Review the Improvements, it will promptly conduct the Review and provide the Punch List to HRSD, but in all instances within ten (10) days of HRSD's delivery of Design-Builder's request for issuance of a certification of substantial completion for the Improvements.

 2. Final Completion. If the Locality provided HRSD with a Punch List, upon receiving notice from HRSD of Design-Builder's request for issuance of a certification of final completion for the Improvements, the Locality may Review the Improvements to confirm that the Punch List has been satisfied. Within ten (10) days of HRSD's delivery of such notice, the Locality will notify HRSD whether it elects to Review the Improvements. If the Locality elects to Review, the Locality will either (i) provide written notice of satisfaction, or (ii) provide written comments identifying all corrections and modifications that the Locality deems necessary for the Improvements to satisfy the Punch List. The Locality will promptly complete the Review, but in all instances within ten (10) days of HRSD's delivery of Design-Builder's request for issuance of a certification of final completion for the Improvements. The process in this paragraph IV(G)(2) will repeat until the Locality provides HRSD written notice of satisfaction which shall not be unreasonably withheld.
- J. JCSA will perform onsite visual inspections of the surface condition of Improvements sufficient to assess any defects, warranty CCTV inspections, and all other applicable HRPDC Regional Construction Standards inspections and deliver any notice of defects identified by said inspections to all Parties within one (1) year of substantial completion of the Improvements to the Locality System.

V. PROJECT COSTS. HRSD shall be responsible for all costs associated with the design and construction of the Improvements, including but not limited to: engineering design costs; costs of preparing the Final Plans and Specifications, and any amendments thereto; cost of construction of the Improvements; costs of advertising for bids; costs of approval and permits required for construction of the Improvements; costs of construction contract administration and inspection by HRSD or its consultants or Design-Builder; costs of all change orders requested solely by HRSD; costs associated with all temporary or permanent easements and land acquisitions associated with the Improvements over third-party property; costs of retiring any existing facilities replaced by the Improvements; and any related miscellaneous essential expenses.

VI. OWNERSHIP, OPERATION, AND MAINTENANCE OF THE LOCALITY SYSTEM AND THE IMPROVEMENTS.

- A. At all times, Locality will own the Locality System and all infrastructure that is related to the Improvements being performed on the Locality System. The Locality hereby grants HRSD, Design-Builder, and their subcontractors and agents a license to access and use any Site to make the Improvements.
- B. Prior to the commencement of construction of the Improvements or any portion thereof, the Locality shall have sole responsibility for maintenance and operation of the Locality System, including that portion that will be subject to work for the Improvements.
- C. During construction of the Improvements, HRSD and the Locality agree to cooperate and coordinate for the operations and maintenance of the Improvements, as well as of any interconnections between Locality's existing facilities and the Improvements; however, the Locality will have responsibility for the maintenance and operation of any sewer segments within the Locality System rehabilitated as part of the Improvements upon such segments being placed back into service.
- D. Upon HRSD's confirmation of substantial completion of the Improvements in coordination with the Locality, the operation and maintenance of the Improvements and all related components of the Locality System are automatically the responsibility of the Locality.

VII. GENERAL PROVISIONS

A. Notices:

1. All notices related to the Initial Comment Period, Final Comment Period, and the design and construction of the Improvements, including as identified in Sections II and IV, and VI shall be deemed effective when delivered by hand-delivery or electronic mail to the following individuals (each a "Program Representative"), unless notice of a new Program Representative is provided in accordance with Section VII(A)(2):

HRSD's Program Representative:
Beatriz E. Patino,
HRSD Project Manager
bpatino@hrsd.com
2389 G. Avenue, Newport News, VA 23602

With a copy to Design-Builder:
Burns and McDonnell Engineering Company Representative:
John J. Pruss
Program Manager
jjpruss@burnsmcd.com
1317 Executive Blvd. Ste 300. Chesapeake, VA 23320

Locality's Program Representative:
JCSA Chief Engineer
James Canning
Phone: (757) 259-4108
Email: james.canning@jcsava.gov
119 Tewning Road, Williamsburg, VA 23188

2. All notices relating to this Agreement, except those related to the Improvements to be delivered to a Party's Program Representative, shall be deemed effective when delivered by hand-delivery, electronic mail with confirmation of receipt, registered mail, or certified mail return receipt requested, postage prepaid, to the Locality and to HRSD at the respective addresses herein shown, unless this Agreement is modified in writing to reflect other addresses:

If to JCSA:

JCSA
c/o General Manager

119 Tewing Road
Williamsburg, VA 23188
Email: doug.powell@jcsava.gov

With copies to:

JCSA Counsel
Andrew Dean, Esq.
James City Service Authority
101-D Mounts Bay Road
Williamsburg, VA 23185
Email: Andrew.dean@jamescitycountyva.gov

If to HRSD:

HRSD
c/o General Manager/CEO
PO Box 5911
Virginia Beach, VA 23471
Email: jbernas@hrsd.com

With Copies to:

HRSD Counsel:
Robyn Hansen, Esq.
Sands Anderson PC
4801 Courthouse Street, Suite 203
Williamsburg, VA 23188
Email: Rhansen@sandsanderson.com

- B. Entire Agreement: This Agreement, and any exhibits or attachments made hereto, represent the full agreement and understanding of the Parties hereto relating to the Improvements, there being no additional agreements written, oral or otherwise. This Agreement may be amended only by a writing signed by both Parties.
- C. Authority: The Locality and HRSD both warrant that they have permission and authority derived under their respective organizational documents and Enabling Acts to execute and undertake this Agreement and that all necessary resolutions and actions of their respective governing bodies to allow execution of this Agreement have been completed. This Agreement shall apply to, and be binding upon both Parties, their elected officials, officers, agents, employees, successors, and assigns.

- D. Compliance with Law: Each Party warrants that, to the best of its knowledge, it has complied with all aspects of applicable federal, state, and local law in entering this Agreement and further warrants that it shall comply with all applicable federal, state, and local laws in the performance of this Agreement.
- E. No Violation: The execution of this Agreement by the Parties will not violate any covenant, condition, or contract to which the Parties hereto are subject at the time of execution.
- F. Insurance. Each Party has the right to review and approve insurance coverage in the various insurance categories that they deem necessary to be carried by the other Party to this Agreement. The Parties acknowledge that the Design-Builder's insurance requirements are governed by the Comprehensive Agreement. Proof of insurance shall be provided at the request of a Party and the insurance coverage shall be maintained during the term of this Agreement.
- G. Governing Law; Venue: This Agreement shall be governed as to all matters whether of validity, interpretations, obligations, performance or otherwise exclusively by the laws of the Commonwealth of Virginia, and all questions arising with respect thereto shall be determined in accordance with such laws without regard to conflict of laws principles. Regardless of where actually delivered and accepted, this Agreement shall be deemed to have been delivered and accepted by the Parties in the Commonwealth of Virginia. Venue shall be in the federal or state courts with jurisdiction in the City of Virginia Beach, Virginia.
- H. Term of Agreement. The term of the Agreement will commence on the date the Agreement is entered into and be completed when each Party has completely performed its obligations hereunder.
- I. Termination. This Agreement may be terminated by Locality or HRSD (i) with cause in the event that a Party materially breaches this Agreement and such breach is not cured within sixty (60) days of the defaulting Party's receipt of written notice of such breach from the non-defaulting Party; or (ii) by mutual written agreement of the Parties.
- J. Enforcement: The failure of either Party to enforce the terms of this Agreement shall not be considered a waiver as to the enforceability of such terms. If any provision of this Agreement is found to be unenforceable, the remainder of this Agreement shall remain in full force and effect. The rights and remedies

provided by this Agreement are cumulative and the use of any one right or remedy by any party shall not preclude or waive the right to use any or all other remedies. Such rights and remedies are given in addition to any other rights the parties may have by law, statute, ordinance or otherwise.

- K. Force Majeure: No Party shall be responsible for its failure to fulfill an obligation pursuant to this Agreement to the extent that such failure is due to acts of God; labor strikes; war or terrorism; epidemics/pandemics; fires; floods; the actions of a third party; lockouts; strikes, freight embargos, and unusually severe weather or delays of Design-Bulder or subcontractors due to such causes. A Party experiencing a force majeure event that prevents fulfillment of a material obligation hereunder shall (a) give the other Party prompt written notice describing the particulars of the event within seven (7) days of the commencement of the event; (b) suspend performance only to the extent and for the duration that is reasonably required by the force majeure event; (c) use reasonable efforts to overcome or mitigate the effects of such occurrence; and (d) promptly resume performance of the affected obligation if and when such Party is able to do so.

- L. Counterparts: This Agreement may be executed in any number of counterparts, each of which shall be deemed to be an original as against any Party whose signature appears thereon, and all of which shall together constitute one and the same instrument.

- M. Assignment. No Party may assign its rights under this Agreement without the prior written consent of the other Party.

- N. No Third-Party Beneficiaries. This Agreement is only intended to address items between the Parties related to the MOA and the Improvements being constructed in the Locality. Any intent to create a third-party beneficiary is expressly disclaimed.

- O. Binding Effect: This Agreement shall inure to the benefit of the Parties and shall, to the maximum extent permitted by law, be binding on the Parties and their successors and permitted assigns.

- P. Reservation: Except as expressly provided herein, nothing in this Agreement shall be construed to limit or otherwise affect the authority, rights, or responsibilities of the Parties.

Q. Recitals. The Recitals above are incorporated into this Agreement as if fully set forth herein.

[Signature pages follow]

IN WITNESS WHEREOF, the James City Service Authority has caused this Agreement to be signed on its behalf by M. Douglas Powell, General Manager of the James City Service Authority, in accordance with authorization granted at its regular meeting held on _____, _____:

JAMES CITY SERVICE AUTHORITY

By: _____
Name: M. Douglas Powell
Title: General Manager

STATE OF VIRGINIA,
CITY or COUNTY OF JAMES CITY, to-wit:

The foregoing Agreement was acknowledged before me this _____ day of _____, 20__, by M. Douglas Powell, General Manager of the James City Service Authority.

Notary Public

My commission expires:

Registration No.:

IN WITNESS WHEREOF, the Hampton Roads Sanitation District Commission has caused this AGREEMENT to be signed on its behalf by its General Manager/CEO in accordance with authorization granted at its regular meeting held on January 27, 2006.

HAMPTON ROADS SANITATION DISTRICT

By: 
Jay Bernas, P.E., General Manager/CEO

COMMONWEALTH OF VIRGINIA
CITY OF VIRGINIA BEACH, to-wit:

The foregoing instrument was acknowledged before me this 5th day of June, 2006 by Jay Bernas, P.E., General Manager/CEO of Hampton Roads Sanitation District. He is personally known to me or provided personally known identification.

Notary Public

Notary#: 7593864
My Commission expires: August 31, 2009

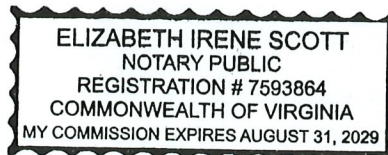

EXHIBIT A

[2014 MOA]

MEMORANDUM OF AGREEMENT

This Memorandum of Agreement ("Agreement") is entered into on this 10 day of ^{March} February, 2014, by and among the Hampton Roads Sanitation District ("HRSD"); and the cities of Chesapeake, Hampton, Newport News, Norfolk, Poquoson, Portsmouth, Suffolk, Virginia Beach, and Williamsburg; the Town of Smithfield; and the counties of Gloucester, Isle of Wight, and York; and the James City Service Authority (each a "Locality" and collectively, the "Localities").

WHEREAS, HRSD provides wastewater transmission and treatment services for the Localities;

WHEREAS, the Localities individually own and operate sanitary sewer collection systems, which collect sewage within their individual jurisdictional boundaries and deliver it to the HRSD sewer system for conveyance and treatment;

WHEREAS, to address regional wet weather sewer capacity requirements, on February 23, 2010, HRSD, the Virginia Department of Environmental Quality and the United States Environmental Protection Agency entered into a Federal Consent Decree;

WHEREAS, the Federal Consent Decree requires, among other things, that HRSD work in consultation with the Localities to develop a Regional Wet Weather Management Plan ("RWWMP") that will ensure adequate wet weather sewer capacity in HRSD's portion of the regional sewer system;

WHEREAS, on June 25, 2012, HRSD, the Localities (excluding Norfolk), and the Commonwealth of Virginia executed an Amendment to the September 26, 2007 Special Order By Consent that requires the Localities (excluding Norfolk) and HRSD to, among other things, develop a RWWMP identical to the plan called for in the Federal Consent Decree;

WHEREAS, on March 17, 2005, HRSD, Norfolk and the Commonwealth of Virginia executed a second phase to the December 17, 2001 Special Order by Consent (collectively, the "Norfolk/HRSD Consent Orders") that required HRSD and Norfolk, to among other things, address wet weather issues in the City of Norfolk with a Long Term Control Plan requiring a minimum annual investment in sewer infrastructure;

WHEREAS, pursuant to the Norfolk/HRSD Consent Orders, the City of Norfolk has made significant financial investments of over \$100 million, though additional capacity-related investments in the Norfolk sewer system are expected as part of further implementation of the Norfolk/HRSD Consent Order (the "Norfolk/HRSD Consent Order Capacity Projects");

WHEREAS, substantial additional wet weather capacity-related investments in the Norfolk sewer system will still be required to achieve the regional wet weather management capacity requirements in the approved RWWMP (the "Norfolk System RWWMP Projects");

WHEREAS, during the ongoing planning for the RWWMP, HRSD and the Localities conducted a study to determine if HRSD ownership of the Localities' sewer systems would provide significant capital and operational cost savings to the region's ratepayers under the RWWMP;

WHEREAS, the regional study was completed in the summer of 2013 and estimated that HRSD ownership of the regional sewers could potentially save the overall region's ratepayers more than one billion dollars over a 30-year period in capital and operation/maintenance costs as compared to a scenario where HRSD and the Localities independently seek to address wet weather capacity needs, although the amount of savings varied significantly among the Localities;

WHEREAS, full regionalization of the Localities' sewer systems is unlikely at this time for a variety of reasons;

WHEREAS, a significant portion of the estimated savings from full regionalization can still be obtained for the benefit of the region's ratepayers if HRSD agrees to take sole responsibility for financing and implementing the approved RWWMP across the entire regional sewer system; and

WHEREAS, if HRSD assumes sole responsibility for funding and implementing the approved RWWMP, HRSD will have to raise its regional rates in order to fund the cost of the approved RWWMP, and each Locality which is a party hereto acknowledges that such rate increases will be necessary in order to achieve the more affordable and cost-effective RWWMP (which each Locality will have the opportunity to provide input into and to challenge if it believes the RWWMP is not an affordable and cost-effective approach);

NOW, THEREFORE, in consideration of the premises, mutual covenants and obligations contained herein, HRSD and the Localities do hereby enter into this Agreement for the purpose of defining the roles, responsibilities, and obligations of HRSD and the Localities for the development, financing, and implementation of the RWWMP and the assurance of adequate wet weather sewer capacity in the Regional Sanitary Sewer System in the future.

A. DEFINITIONS

"2007 MOA" means the Memorandum of Agreement dated June 28, 2007, by and among HRSD; the cities of Chesapeake, Hampton, Newport News, Poquoson, Portsmouth, Suffolk, Virginia Beach, and Williamsburg; the Town of Smithfield; the counties of Gloucester, Isle of Wight, and York; and the James City Service Authority.

"Board" means the State Water Control Board, a permanent citizens body of the Commonwealth of Virginia as described in Virginia Code §§ 62.1-44.7 and 10.1-1184.

"DEQ" means the Department of Environmental Quality, an agency of the Commonwealth of Virginia as described in Virginia Code §10.1-1183.

"EPA" means the United States Environmental Protection Agency.

"Federal Consent Decree" means the Amended Consent Decree filed in the United States District Court for the Eastern District of Virginia on February 23, 2010 (Civil Action No. 2:09cv-481), and any subsequent amendments thereto.

"Party" or "Parties" means one or more signatories to this Agreement.

"Regional Sanitary Sewer System" means the collective sanitary sewer systems owned and operated by HRSD and the Localities, including gravity sewer lines, manholes, pump stations, lift stations, pressure reducing stations, force mains, wastewater treatment plants, and all associated appurtenances.

"Special Order By Consent" means the special order by consent dated September 26, 2007, and any subsequent amendments thereto, by and among the Board and HRSD; the cities of Chesapeake, Hampton, Newport News, Poquoson, Portsmouth, Suffolk, Virginia Beach, and Williamsburg; the Town of Smithfield; the counties of Gloucester, Isle of Wight, and York; and the James City Service Authority.

"Significant Defect" means a physical condition in the sanitary sewer system owned or

operated by a Locality, including: (i) existing or imminent structural failures, cave-ins, and similar defects and (ii) significant sources of inflow and infiltration (including but not limited to missing and/or damaged public clean-outs, missing manhole inserts, direct storm water connections, and unsealed manhole pipe penetrations).

“Warranties” means any warranties and/or rights under bonds or similar instruments securing or assuring the quality, adequacy or timeliness of the design, materials, installation or construction of any improvements conveyed by HRSD to a Locality as contemplated in this Agreement.

B. ROLES AND RESPONSIBILITIES

1. HRSD agrees to:

a. In consultation with the Localities: Develop a reasonably affordable and cost-effective RWWMP, including the Norfolk System RWWMP Projects, in accordance with this Agreement and Paragraph 10 of the Federal Consent Decree, to achieve the wet weather capacity requirements of the Federal Consent Decree for the affected portions of the Regional Sanitary Sewer System including the Norfolk sewer system.

b. Implement the approved RWWMP in accordance with the approved RWWMP long-term schedule;

c. Design and construct all RWWMP projects in accordance with HRSD Standards and Preferences, the applicable portions of the Hampton Roads Planning District Commission Regional Construction Standards, and Locality preferences, policies, or guidelines with respect to operation and maintenance issues where such preferences, policies, or guidelines have been established and are broadly applied by the Locality;

d. Fully fund implementation of the RWWMP regardless of asset ownership through a regional HRSD rate applied equally across all HRSD accounts in the Localities;

e. Upon full implementation of the applicable RWWMP facilities for each HRSD treatment plant service area and the successful completion of the Post-RWWMP Performance Assessment for that service area, HRSD shall be responsible for ensuring and maintaining adequate wet weather capacity for those portions of the Regional Sanitary Sewer System in that service area, whether owned or operated by HRSD or a Locality, up to the applicable capacity level defined in the approved RWWMP;

f. Maintain a flow monitoring program in accordance with the Federal Consent Decree;

g. Investigate, in cooperation with affected Localities, any sanitary sewer overflow where system capacity is reasonably suspected of being a contributing cause or the sole cause of such overflow to determine the actual cause or causes (in support of such inquiry, HRSD shall make available to Localities in a timely manner, upon request, any potentially relevant information it may have) and the appropriate response;

h. Provide to the applicable Locality complete copies of record drawings of improvements constructed by HRSD within that Locality pursuant to the RWWMP within thirty (30) days of completion or amendment of such drawings;

i. Convey to each Locality improvements which HRSD may install or construct pursuant to the approved RWWMP, for addition or modification to the Locality’s sewer system;

j. Negotiate and obtain customary commercial Warranties for pavement and other project improvements in Locality systems and enforce such Warranties during warranty periods as necessary, provided that following such warranty period, any assets conveyed to a Locality are the sole responsibility of such Locality;

k. Make available to the Localities information HRSD uses in the development and implementation of the RWWMP and any other relevant information HRSD may have;

l. Comply with applicable Locality ordinances and other laws and regulations in the planning, design, and implementation of the RWWMP;

m. Assume regulatory liability for wet weather overflows occurring upon completion of the RWWMP implementation (including the Post RWWMP Implementation Performance Assessment) and which are determined to result from lack of adequate capacity as defined in the RWWMP for such sanitary sewer overflows;

n. Reimburse, to the extent permitted by law, any Locality for reasonable claims paid to any third-party resulting from wet weather overflows occurring upon completion of the RWWMP implementation (including the Post RWWMP Implementation Performance Assessment) and which are determined to result from lack of adequate capacity as defined in the RWWMP for such sanitary sewer overflows, provided that HRSD retains the right to assert governmental immunity as allowed by law if HRSD determines a claim is unreasonable or due to causes beyond HRSD's control;

o. Provide staff and/or consultant resources to coordinate development and implementation of the approved RWWMP as it applies to each Locality in accordance with the approved RWWMP schedule;

p. Issue in a timely manner and in accordance with established processes any approvals, and timely execute any documents, necessary for implementation by a Locality of improvements or management, operations or maintenance measures as required by the RWWMP or contemplated by the Special Order by Consent, and not unreasonably withhold, condition or delay such approvals or execution of documents;

q. Support the modification of the Special Order by Consent between DEQ, HRSD and the Localities consistent with the changes to the Federal Consent Decree;

r. Consult with the Localities as necessary to facilitate the timely implementation of the approved RWWMP; and

s. Cooperate with Localities when requested to incorporate other locally funded infrastructure improvements as part of any RWWMP project, provided that HRSD can do so consistent with the approved RWWMP schedule and HRSD's project-related costs do not increase by more than ten percent (10%) (a Locality may pay any amount of additional HRSD cost above the 10% threshold in order to satisfy this condition).

2. Each Locality agrees to:

a. Maintain and operate Locality-owned collection system assets and any improvements constructed by HRSD in Locality-owned assets as part of the RWWMP. This obligation shall be performed in accordance with any approved Management, Operations, and Maintenance program and industry accepted practices relating to sewer inspection, Sewer System Evaluation Survey work and repair of Significant Defects (not scheduled to be addressed by the

RWWMP within a reasonable period of time but excluding those for which HRSD is responsible under Section B.1.j above);

b. Provide full access to data, information and Locality-owned assets necessary for timely and cost-effective development of the RWWMP. This includes, but is not limited to, flow monitoring data, calibrated hydrologic models, long-term simulations, SSES data and results, Rehabilitation Plans and Preliminary Capacity Assessments including hydraulic models and related calculations;

c. Maintain and calibrate the existing locality-owned flow monitoring equipment (previously required by the Regional Technical Standards) and provide data at regular intervals in a mutually acceptable form, throughout the development of the RWWMP;

d. Provide staff and/or consultant resources to coordinate development and implementation of the approved RWWMP as it applies to each Locality in accordance with the approved RWWMP schedule, subject to appropriation, provided that in the event adequate resources are not appropriated, HRSD shall be relieved of its obligations under Section B.1.a with respect to consultation with the Localities and Section B.1.q of this Agreement;

e. Timely issue any Locality administrative permits in accordance with established processes and, subject to applicable law, timely execute any documents, as necessary for implementation of RWWMP-related improvements in that Locality, and not unreasonably withhold, condition or delay such permits or execution of documents;

f. Accommodate reasonable contractor requests for standard work hours and maintenance of traffic in accordance with existing Locality policies during implementation of RWWMP improvements within the Locality;

g. Support the modification of the September 26, 2007 Special Order by Consent, as amended, between DEQ, HRSD and the Localities consistent with the changes to the Federal Consent Decree;

h. Upon HRSD's request, provide a written letter of support for a modification of HRSD's Federal Consent Decree to establish HRSD's responsibilities consistent with this Agreement;

i. Cooperate with HRSD and the other Localities as necessary to facilitate the timely implementation of the approved RWWMP; and

j. Provide timely notice of and investigate, in cooperation with HRSD, all capacity-related sanitary sewer overflows.

C. REMEDIES AND RESERVATIONS OF RIGHTS

1. If any Party shall fail to perform or observe any of the material terms, conditions, or provisions of this Agreement applicable to it, and said failure is not rectified or cured within thirty (30) days after receipt of written notice thereof from another Party, then the defaulting Party shall be deemed in breach of this Agreement; provided, however, that no Party shall have a right to issue a notice of default pursuant to this Section C.1 until the dispute resolution procedures set forth in Section C.2 below have been exhausted. The Parties agree that, in the event of a material breach of this Agreement, a non-defaulting Party, which is or would be harmed by the breach, may seek injunctive relief or specific performance of the defaulting Party's obligations without the requirement to post a bond. The Parties acknowledge that each Party's performance of its material

obligations is valuable and unique and that, for purposes of allowing the non-defaulting Party to seek injunctive relief, the failure of a Party to perform its material obligations hereunder may result in irreparable injury to the other Parties. Nothing in this Agreement shall be deemed to modify, alter, or otherwise affect such other rights and remedies as may be available to the Parties under applicable law or equity.

2. If any dispute arises with respect to the alleged failure of any Party to perform or observe any of the material terms, conditions, or provisions of this Agreement applicable to it, as a condition precedent to instituting a formal action in a court with competent jurisdiction, the parties shall first attempt to resolve the dispute through the dispute resolution procedures contained in this Section C.2. A Party may initiate the dispute resolution procedures of this Section C.2 by providing to the other Parties to the dispute written notice of the existence and nature of the dispute. Within thirty (30) days of such notice, the Parties to the dispute shall meet and attempt in good faith to resolve the dispute. Upon the request of any Party to the dispute, the Parties to the dispute shall participate in non-binding mediation. The mediator shall be selected by mutual agreement of the Parties to the dispute, and the cost of the mediator shall be shared equally by those Parties engaged in the mediation. If the dispute cannot be resolved within sixty (60) days after receipt of written notice of the dispute or any reasonable extension as may be mutually agreed upon by the Parties, then any Party to the dispute may elect to end dispute resolution by providing written notice of such election to the other Parties to the dispute, in which case the dispute resolution procedures shall be deemed to have been exhausted. The dispute resolution procedures may also be deemed exhausted by written agreement of all the Parties to the dispute.

3. Nothing herein shall be construed as or otherwise constitute a waiver or release by any Party of any right, power, immunity, or standing of that Party that may exist pursuant to applicable law or regulation, including, without limitation, such right or standing to appeal or seek review of any case decision or other reviewable determination of the Board, DEQ, EPA, a Court having jurisdiction over the dispute, or any other agency or governmental body related to the matters addressed in this Agreement, the Federal Consent Decree, or the Special Order By Consent.

D. MISCELLANEOUS

1. Amendments to Agreement. Amendments to this Agreement must be in writing and signed by all the Parties.

2. Entire Agreement. This Agreement contains the entire agreement among the Parties with respect to the subject matter hereof and supersedes all prior agreements, written or oral, with respect thereto, including the 2007 MOA.

3. Severability. If any provision of this Agreement is found to be unenforceable, the remainder of this Agreement shall remain in full force and effect.

4. Authority. The Parties represent that they have the authority to enter into this Agreement and that the individuals signing this Agreement on their behalf have the requisite power and authority to bind the Parties to its terms and conditions. This Agreement shall apply to, and be binding upon the Parties, their elected officials, officers, agents, employees, successors, and assigns.

5. Reservation. Except as expressly provided herein, nothing in this Agreement shall be construed to limit or otherwise affect the authority, rights, or responsibilities of the Parties.

6. Notices and Written Communications. All notices and written communication pursuant to this Agreement shall be submitted to the recipients listed in Attachment A. A Party may change its designated notice recipient by so informing all other Parties in writing.

7. Effective Date. This Agreement shall be effective and binding upon its execution by all Parties and shall continue in effect until terminated in accordance with Section D.11.

8. Governing Law. This Agreement shall be governed and construed in accordance with the laws of the Commonwealth of Virginia, without regard to the conflict of laws and rules thereof.

9. Force Majeure. No Party shall be responsible for its failure to fulfill an obligation pursuant to this Agreement to the extent that such failure is due to acts of God; strikes; war or terrorism; the actions of a third party; the actions of another Party; lockouts; or other events not reasonably within the control of the Party claiming force majeure. A Party experiencing a force majeure event that prevents fulfillment of a material obligation hereunder shall (a) give the other Parties prompt written notice describing the particulars of the event; (b) suspend performance only to the extent and for the duration that is reasonably required by the force majeure event; (c) use reasonable efforts to overcome or mitigate the effects of such occurrence; and (d) promptly resume performance of the affected obligation if and when such Party is able to do so.

10. Counterparts. This Agreement may be executed in any number of counterparts, each of which shall be deemed to be an original as against any Party whose signature appears thereon, and all of which shall together constitute one and the same instrument.

11. Termination. This Agreement shall terminate (a) if the Motion to Amend the Federal Consent Decree contemplated herein is either not filed with the Court by May 31, 2014 or is filed but denied by the Court; (b) if the Federal Consent Decree is not amended as contemplated herein by August 31, 2014; (c) if the State Special Order by Consent is not, by December 31, 2014, either (1) rescinded in its entirety or (2) amended to relieve the Localities of any obligation to develop, fund, and implement the Regional Wet Weather Management Plan; or (d) upon the written agreement of all Parties. If this Agreement is terminated for any reason, except upon the agreement of HRSD, then HRSD reserves the right to assert a force majeure under the Federal Consent Decree.

12. Not for Benefit of Third Parties. This Agreement and each and every provision hereof is for the exclusive benefit of the Parties and not for the benefit of any third party.

13. Binding Effect. This Agreement shall inure to the benefit of the Parties and shall, to the maximum extent permitted by law, be binding on the Parties and their successors and assigns.

[REST OF PAGE INTENTIONALLY LEFT BLANK]

IN WITNESS WHEREOF, the Parties have caused this Agreement to be executed by their duly authorized officials as of the dates next to their respective signatures as shown below.

By: [Signature]
Date: 2-27-2014
Locality: City of Chesapeake

By: [Signature]
J. Randall Wheeler
Poquoson City Manager
Date: 2/26/13
Locality: City of Poquoson

By: [Signature]
Date: February 25, 2014
Locality: Gloucester County

By: [Signature]
John L. Rowe, Jr., City Manager
Date: FEB 26, 2014
Locality: City Of Portsmouth

By: [Signature]
Mary B. Bunting, City Manager
Date: 2/18/2014
Locality: City of Hampton

By: [Signature]
Peter M. Stephenson
Town Manager
Date: 02/04/2014
Locality: Town of Smithfield

adopted the 20th day of February, 2014.

[Signature]
Byron B. Bailey, Chairman
Isle of Wight County
Board of Supervisors

By: [Signature]
Selena Cuffee-Glehn, City Manager
Date: 2/27/14
Locality: City of Suffolk, Virginia

By: [Signature]
Date: 2/26/2014
Locality: JAMES CITY COUNTY

Date: 2.12.14
By: [Signature]
City Manager
Locality: City of Williamsburg

Date: 2/14/14
By: [Signature]
City Manager
Locality: City of Newport News

By: [Signature]
James O. McReynolds
County Administrator
Date: 2-24-2014
Locality: County of York

By: [Signature]
City Manager
Date: 3/10/14
Locality: City of Norfolk

Date: 2/26/2014
By: [Signature]
General Manager
Locality: HRSD

LIST OF SIGNATORIES

CITY OF CHESAPEAKE

GLOUCESTER COUNTY

CITY OF HAMPTON

ISLE OF WIGHT COUNTY

JAMES CITY COUNTY

CITY OF NEWPORT NEWS

CITY OF NORFOLK

CITY OF POQUOSON

CITY OF PORTSMOUTH

CITY OF SUFFOLK

CITY OF VIRGINIA BEACH

CITY OF WILLIAMSBURG

YORK COUNTY

TOWN OF SMITHFIELD

HAMPTON ROADS SANITATION DISTRICT

This listing of participants is followed by the signature page to be completed by each party.

IN WITNESS WHEREOF, the Party has caused this Agreement to be executed by their duly authorized officials as shown below.

By: 

Date: 2-27-2014

Locality: City of Chesapeake

Date: 2-27-2014

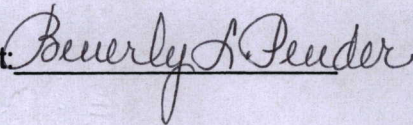
Attest: 

Approved as to Form

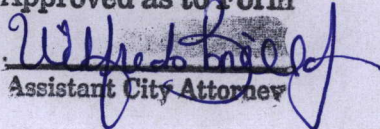
Assistant City Attorney

IN WITNESS WHEREOF, the Party has caused this Agreement to be executed by their duly authorized officials as shown below.

By: Brenda H. Garton

Date: February 25, 2014

Locality: Gloucester County

Date: February 25, 2014

Attest: Patricia L. Conner

IN WITNESS WHEREOF, the Party has caused this Agreement to be executed by their duly authorized officials as shown below.

By: Mary B. Bunting
Mary B. Bunting, City Manager

Date: 2/18/2014

Locality: City of Hampton

Date: 2/19/14

Attest: Katherine K. Glass
Katherine K. Glass
Clerk of Council

CITY OF HAMPTON
OFFICE OF THE CITY ATTORNEY
Approved as to legal form and sufficiency
Date: 02.18.2014
[Signature]
Attorney

Approved by the Isle of Wight County Board of Supervisors at a regular meeting by motion duly adopted the 20th day of February, 2014.

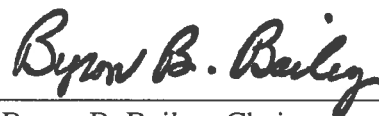

Byron B. Bailey, Chairman
Isle of Wight County
Board of Supervisors

Attested:



Carey Mills Storm, Clerk

Approved as to form:



Mark C. Popovich, County Attorney

IN WITNESS WHEREOF, the Party has caused this Agreement to be executed by their duly authorized officials as shown below.

By: M. D. P. P. P.

Date: 2 / 26 / 2014

Locality: JAMES CITY COUNTY

Date: 2 / 26 / 2014

Attest: Lune Sellorff

IN WITNESS WHEREOF, the City of Newport News has caused this Agreement to be executed by their duly authorized official as shown below:

Date: 2/14/14

By: James M. Bourey
City Manager

Commonwealth of Virginia
City of Newport News

The foregoing instrument was acknowledged before me this 20th day of February by James M. Bourey, City Manager, on behalf of the City of Newport News. ²⁰¹⁴

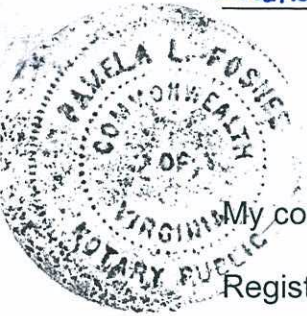

Paul L. Foshee
Notary Public

My commission expires: 8-31-2014

Registration No: 299515

APPROVED AS TO FORM:

[Signature]
Deputy City Attorney

ATTEST:

Thapel Washington Jenkins
City Clerk

IN WITNESS WHEREOF, the Party has caused this Agreement to be executed by their duly authorized officials as shown below.

By: Marcus A. Jones
City Manager

Date: 3/10/14

Locality: City of Norfolk

Date: 3/11/14

Attest: Robert J. [Signature]
City Clerk

Contents Approved:

Kristen M. [Signature]
Director of Utilities

Form & Correctness Approved:

[Signature]
City Attorney

IN WITNESS WHEREOF, the Party has caused this Agreement to be executed by their duly authorized officials as shown below.

By: 
J. Randall Wheeler
Poquoson City Manager

Date: 2/26/13

Locality: City of Poquoson

Date: 2/26/2014

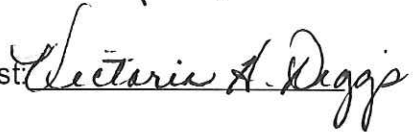
Attest: 

IN WITNESS WHEREOF, the Party has caused this Agreement to be executed by their duly authorized officials as shown below.

By: John L. Rowe

John L. Rowe, Jr., City Manager

Date: FEB 26, 2014

Locality: City Of Portsmouth

Date: Feb 26, 2014

Attest: Debra Y. White

IN WITNESS WHEREOF, the Party has caused this Agreement to be executed by their duly authorized officials as shown below.

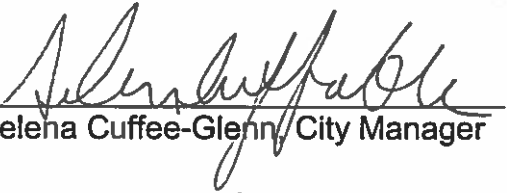
By: 
Selena Cuffee-Glenn, City Manager

Date: 2/27/14

Locality: City of Suffolk, Virginia

Date: _____

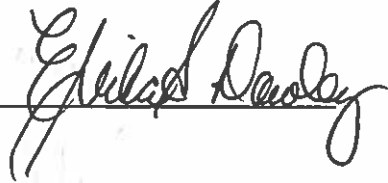
Attest: 

IN WITNESS WHEREOF, the City of Virginia Beach has caused this Agreement to be executed by their duly authorized official as shown below.

Date: 2.12.14

By:  DCM
City Manager

Commonwealth of Virginia *Attest: Great Lodge Mason, mnc*
City of Virginia Beach: *city clerk*

The foregoing instrument was acknowledged before me this 14th day of February, 2014 by ~~James K. Spore, City Manager~~, on behalf of the City of Virginia Beach..
David L. Hansen, Deputy City Manager

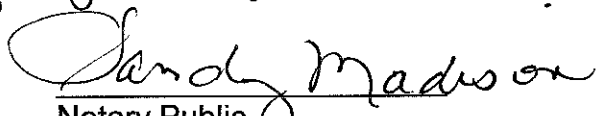
Notary Public

My commission expires: 12-31-14

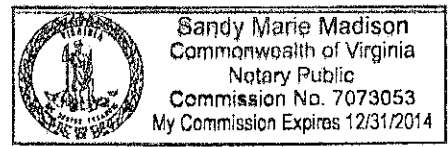

Approved as to Content:

Approved as to Legal Sufficiency:

Dept. of Public Utilities

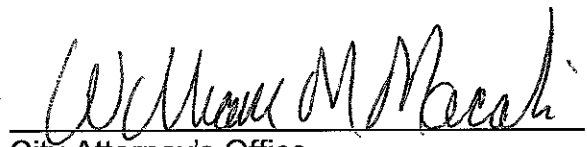
City Attorney's Office

IN WITNESS WHEREOF, the Party has caused this Agreement to be executed by their duly authorized officials as shown below.

By: 

Date: 2/14/2014

Locality: City of Williamsburg

Date: 2/14/14

Attest: Dan Clayton, DIRPW

IN WITNESS WHEREOF, the Party has caused this Agreement to be executed by their duly authorized officials as shown below.

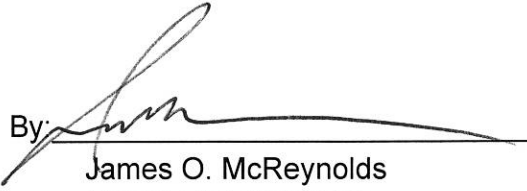
By: 
James O. McReynolds
County Administrator

Date: 2-24-2014

Locality: County of York

Date: 2-24-2014

Attest: 

IN WITNESS WHEREOF, the Party has caused this Agreement to be executed by their duly authorized officials as shown below.



By: *Peter M. Stephenson*
Peter M. Stephenson
Town Manager
Date: 02/04/2014
Locality: Town of Smithfield

Date: 2-4-14

Attest: *Lesley A. King*

IN WITNESS WHEREOF, HRSD has caused this Agreement to be executed by their duly authorized official as shown below.

Date: 2/26/2014

By: 
General Manager

Commonwealth of Virginia
City/County of Virginia Beach

The foregoing instrument was acknowledged before me this 26th day of February, 2014 by Ted Henifin, General Manager of HRSD, on behalf of HRSD.

Notary Public

My commission expires: August 30, 2017



ATTACHMENT A

List of Individuals to Receive Notices Pursuant to Paragraph D.6:

Mr. James E. Baker
City Manager
City of Chesapeake
306 Cedar Road, 6th Floor
Chesapeake, VA 23328

Ms. Brenda G. Garton
County Administrator
Gloucester County
6467 Main Street
Gloucester, VA 23061-0329

Ms. Mary Bunting
City Manager
City of Hampton
22 Lincoln Street
Hampton, VA 23669

Ms. Anne Seward
County Administrator
Isle of Wight County
17090 Monument Crescent, Suite 138
Isle of Wight, VA 23397

Mr. Douglas Powell
Interim County Administrator
James City County
101C Mounts Bay Rd
Williamsburg, VA 23187-8784

Mr. Jim Bourey
City Manager
City of Newport News
2400 Washington Avenue
Newport News, VA 23607

Mr. Marcus Jones
City Manager
City of Norfolk
1101 City Hall Building
810 Union Street
Norfolk, VA 23510

Mr. J. Randall Wheeler
City Manager
City of Poquoson
500 City Hall Avenue
Poquoson, VA 23662

Mr. John L. Rowe Jr.
City Manager
City of Portsmouth
801 Crawford Street
Portsmouth, VA 23704

Ms. Selena Cuffee-Glenn
City Manager
City of Suffolk
PO Box 1858
Suffolk, VA 23439

Mr. James K. Spore
City Manager
City of Virginia Beach
2401 Courthouse Drive, Suite 243
Virginia Beach, VA 23456

Mr. Jackson C. Tuttle II
City Manager
City of Williamsburg
401 Lafayette Street, Suite 202
Williamsburg, VA 23185

Mr. James O. McReynolds
County Administrator
York County
224 Ballard Street
Yorktown, VA 23690

Mr. Peter M. Stephenson AICP
Town Manager
Town of Smithfield
315 Main Street
Smithfield, VA 23431

Mr. Edward G. Henifin
Hampton Roads Sanitation District
PO Box 5911
Virginia Beach, VA 23471

HRSD Commission Meeting Minutes
January 27, 2026
Attachment #6

9. HRSD West Point Virginia Department of Environmental Quality Enforcement Action Order by Consent



Commonwealth of Virginia

VIRGINIA DEPARTMENT OF ENVIRONMENTAL QUALITY

www.deq.virginia.gov

Stefanie K. Taillon
Secretary of Natural and Historical Resources

Michael S. Rolband, PE, PWD, PWS Emeritus
Director

VIRGINIA DEPARTMENT OF ENVIRONMENTAL QUALITY
ENFORCEMENT ACTION - ORDER by CONSENT
ISSUED to

Hampton Roads Sanitation District

FOR
UNAUTHORIZED DISCHARGES

SECTION A: Purpose

This is a Consent Order issued under the authority of Va. Code § 62.1-44.15 for the purpose of resolving certain violations of the State Water Control Law and the applicable regulations.

SECTION B: Definitions

Unless the context clearly indicates otherwise, the terms used in this Consent Order have the meanings assigned to them in Va. Code § 62.1-44.2 et seq. and 10.1-1182 et seq.

SECTION C: Findings of Fact and Conclusions of Law

Table with 4 columns and 6 rows containing enforcement details: Responsible Party, Location of Discharge, Warning Letter(s), Receiving Water Information, Description of fish kill or impacts to the waterbody, and a concluding statement about the Responsible Party.

The Department has issued no permits or certificates to the Responsible Party for the discharge into state waters.

Va. Code § 62.1-44.15(5a) states that a VPDES permit is a “certificate” under the statute.

The receiving water is a surface water located wholly or partially within the Commonwealth and is a “state water” under State Water Control Law.

Violation	Observations and Legal Requirements	Civil Charge			Subtotal
			# of Occurrences		
✓	Unauthorized discharges into state waters. Va. Code § 62.1-44.5(A) 9 VAC 25-31-50(A)	Serious		Serious Subtotal	\$ 0
		\$ 13,229		\$ 0	
		Moderate		Moderate Subtotal	
		\$ 6,615		\$ 0	
		Marginal		Marginal Subtotal	
		\$ 1,323		\$ 0	
	Failure to report the discharge into state waters to the Department or the coordinator of emergency services appointed for the political subdivision. Va. Code § 62.1-44.5(B) 9VAC25-31-50(B)	Serious		Serious Subtotal	\$ 0
		\$ 13,229		\$ 0	
		Moderate		Moderate Subtotal	
		\$ 6,615		\$ 0	
		Marginal		Marginal Subtotal	
		\$ 1,323		\$ 0	
Violation Component Civil Charge Subtotal					\$ 0

Aggravating Factors		
	Additional Civil Charge Assessment	Subtotal
Major Facility	No	\$ 0.00
Consent Order in another media Program within 36 months	No	\$ 0.00
Consent Order in the same media program within 36 months	No	\$ 0.00
Degree of Culpability	Low	\$ 0.00
Aggravating Factors Subtotal:		\$ 0.00
Civil Charge Subtotal and Aggravating Factor Subtotal:		\$ 0.00
Flow Reduction Factor	No	\$ 0.00

Gravity Based Component Subtotal		\$ 0.00
Cooperativeness and Quick Settlement	No	\$ 0.00
Economic Benefit of Noncompliance	No	
In accordance with 62.1-44.15(8d), the Responsible Party's Ability to Pay was evaluated and it was determined that there is an ability to pay.	Yes	
Total Civil Charge:		\$ 0.00
Based on the results of staff observations, the Department concludes that the Responsible Party has violated the Va. Code and Regulations as identified herein.		

SECTION D: Agreement and Order

Accordingly, by virtue of the authority granted it in Va. Code §§ 62.1-44.15, the Department orders the Responsible Party, and the Responsible Party agrees to:

- Perform the actions described in Appendix A of this Order.
- Pay the total civil charge of \$ 0.00 in settlement of the violations cited in this Consent Order in accordance with the following:
 - Within 30 days of the effective date of the Order, or
 - In accordance with the following payment schedule:

Due Date	Amount

If the Department fails to receive a civil charge payment pursuant to the schedule described above, the payment shall be deemed late. If any payment is late by 30 days or more, the entire remaining balance of the civil charge shall become immediately due and owing under this Order, and the Department may demand in writing full payment by Responsible Party. Within 15 days of receipt of such letter, Responsible Party shall pay the remaining balance of the civil charge. Any acceptance by the Department of a late payment or of any payment of less than the remaining balance shall not act as a waiver of the acceleration of the remaining balance under this Order.

Payment shall be made by either credit card at www.deq.virginia.gov or check, certified check, money order or cashier's check payable to the "Treasurer of Virginia," and delivered to:

Receipts Control
Department of Environmental Quality
Post Office Box 1104
Richmond, VA 23218

The Responsible Party shall include its Federal Employer Identification Number (FEIN) with the civil charge payment and shall indicate that the payment is being made in accordance with the requirements of this Order for deposit into the Virginia Environmental Emergency Response Fund (VEERF). If the Department has to refer collection of moneys due under this Order to the Department of Law, Responsible Party shall be liable for attorneys' fees of 30% of the amount outstanding.

SECTION E: Administrative Provisions

1. The Department may modify, rewrite, or amend this Order with the consent of the Responsible Party for good cause shown by the Responsible Party, or on its own motion pursuant to the Administrative Process Act, Va. Code § 2.2-4000 *et seq.*, after notice and opportunity to be heard.
2. This Order addresses and resolves only those violations specifically identified in Section C of this Order. This Order shall not preclude the Department or the Director from taking any action authorized by law, including but not limited to: (1) taking any action authorized by law regarding any additional, subsequent, or subsequently discovered violations; (2) seeking subsequent remediation of the facility; or (3) taking subsequent action to enforce the Order.
3. For purposes of this Order and subsequent actions with respect to this Order only, the Responsible Party admits the jurisdictional allegations, and agrees not to contest, but neither admits nor denies, the findings of fact and conclusions of law in this Order.
4. The Responsible Party consents to venue in the Circuit Court of the City of Richmond for any civil action taken to enforce the terms of this Order.
5. The Responsible Party declares it has received fair and due process under the Administrative Process Act and the State Water Control Law and it waives the right to any hearing or other administrative proceeding authorized or required by law or regulation, and to any judicial review of any issue of fact or law contained herein. Nothing herein shall be construed as a waiver of the right to any administrative proceeding for, or to judicial review of, any action taken by the Department to modify, rewrite, amend, or enforce this Order.
6. Failure by the Responsible Party to comply with any of the terms of this Order shall constitute a violation of an order of the Department. Nothing herein shall waive the initiation of appropriate enforcement actions or the issuance of additional orders as appropriate by the Department or the Director as a result of such violations. Nothing herein shall affect appropriate enforcement actions by any other federal, state, or local regulatory authority.
7. If any provision of this Order is found to be unenforceable for any reason, the remainder of the Order shall remain in full force and effect.

8. The Responsible Party shall be responsible for failure to comply with any of the terms and conditions of this Order unless compliance is made impossible by earthquake, flood, other acts of God, war, strike, or such other unforeseeable circumstances beyond its control and not due to a lack of good faith or diligence on its part. The Responsible Party shall demonstrate that such circumstances were beyond its control and not due to a lack of good faith or diligence on its part. The Responsible Party shall notify the DEQ Enforcement Director verbally within 24 hours and in writing within three business days when circumstances are anticipated to occur, are occurring, or have occurred that may delay compliance or cause noncompliance with any requirement of the Order. Such notice shall set forth:
 - a. the reasons for the delay or noncompliance;
 - b. the projected duration of any such delay or noncompliance;
 - c. the measures taken and to be taken to prevent or minimize such delay or noncompliance; and
 - d. the timetable by which such measures will be implemented and the date full compliance will be achieved.

Failure to so notify the Enforcement Director verbally within 24 hours and in writing within three business days, of learning of any condition above, which the parties intend to assert will result in the impossibility of compliance, shall constitute a waiver of any claim to inability to comply with a requirement of this Order.

9. This Order is binding on the parties hereto and any successors in interest, designees and assigns, jointly and severally.
10. This Order shall become effective upon execution by both the Director or his designee and The Responsible Party. Nevertheless, the Responsible Party agrees to be bound by any compliance date which precedes the effective date of this Order.
11. This Order shall continue in effect until:
 - a. The Director or his designee terminates the Order after the Responsible Party has completed all of the requirements of the Order;
 - b. The Responsible Party petitions the Director or his designee to terminate the Order after it has completed all of the requirements of the Order and the Director or his designee approves the termination of the Order; or
 - c. The Director or Department terminates the Order in his or its sole discretion upon 30 days' written notice to Responsible Party.

Termination of this Order, or any obligation imposed in this Order, shall not operate to relieve the Responsible Party from its obligation to comply with any statute, regulation, permit condition, other order, certificate, certification, standard, or requirement otherwise applicable.

12. Any plans, reports, schedules or specifications attached hereto or submitted by the Responsible Party and approved by the Department pursuant to this Order are incorporated into this Order. Any non-compliance with such approved documents shall be considered a violation of this Order.

13. The undersigned representative of the Responsible Party certifies that he or she is a responsible official or officer authorized to enter into the terms and conditions of this Order and to execute and legally bind the Responsible Party to this document. Any documents to be submitted pursuant to this Order shall also be submitted by a responsible official of Responsible Party.

14. This Order constitutes the entire agreement and understanding of the parties concerning settlement of the violations identified in Section C of this Order, and there are no representations, warranties, covenants, terms or conditions agreed upon between the parties other than those expressed in this Order.

15. By its signature below, the Responsible Party voluntarily agrees to the issuance of this Order.

And it is so ORDERED.

DEQ Signee Signature

Date

DEQ Signee Name

Title

I hereby certify that I am the Responsible Party or duly appointed representative/officer of the Responsible Party.

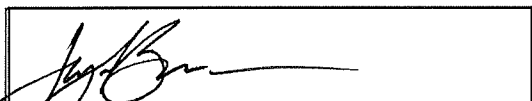

RP Signee Signature

Date

RP Signee Name

Title

**APPENDIX A
SCHEDULE OF COMPLIANCE**

The Responsible Party shall take the following actions:

Corrective Actions to be Performed	Due Date
1. HRSD shall continue to conduct illicit discharge investigations to identify inflow/infiltration into the HRSD West Point collection system. HRSD shall submit a summary report describing the results of any illicit connection investigation findings and include corrective actions planned to reduce and eliminate the located illicit discharge(s).	Due December 31, 2026
2. Per NOV Response provided by HRSD dated September 8, 2025 and December 3, 2025, complete the Capital Improvement Projects listed below and provide notification to DEQ within 10 days of project completion: <ul style="list-style-type: none"> 1. MP014800 Small Communities Rehabilitation Phase V 2. MP015500 Small Communities Rehabilitation Phase VI 3. MP015600 West Point TP Effluent Pump Station Rehabilitation 4. MP015610 West Point Treatment Plant Generator Installation 5. MP015700 West Point TP Secondary Clarifier System Rehabilitation 	Complete project and submit notification to DEQ due by: <ul style="list-style-type: none"> 1. August 30, 2026 2. June 30, 2027 3. June 30, 2028 4. October 31, 2026 5. June 30, 2028

DEQ Contact

Unless otherwise specified in this Order, the Responsible Party shall submit all requirements of Appendix A of this Order to:

DEQ Enforcement c/o Cara Witte 4949-A Cox Road Glen Allen, Virginia 23060 804-712-4192 / cara.witte@deq.virginia.gov

HRSD Commission Meeting Minutes
January 27, 2026
Attachment #7

10. Capital Improvement Program (CIP)
Update

A dynamic splash of clear water with numerous bubbles, set against a light blue and white background. The water is captured in mid-air, creating a sense of movement and freshness.

Capital Improvement Program Commission Briefing

January 27, 2026



- CIP Expenditures, Performance, and Enhancements
- Regulatory Compliance
- SWIFT Program
- High Priority I/I Reduction Program
- Project Spotlight

SAVE THE DATE!

HRSD's 7th Annual Industry Day

(formerly SWIFT Industry Day)

Thursday, January 29, 2026

8:00 a.m. – 12:30 p.m. at the

Holiday Inn – Newport News Hampton

Industry Day is an opportunity for engineers, contractors, vendors, and suppliers, including Small, Women-owned, Minority-owned, Military Family-owned, and Service-Disabled Veteran-owned businesses to attend. **New this year, Industry Day will cover both HRSD and SWIFT Projects!**



REGISTER TODAY
AT [HRSDINDUSTRYDAY.COM](https://hrsdindustryday.com)



CIP Expenditures & Reimbursements for FY26

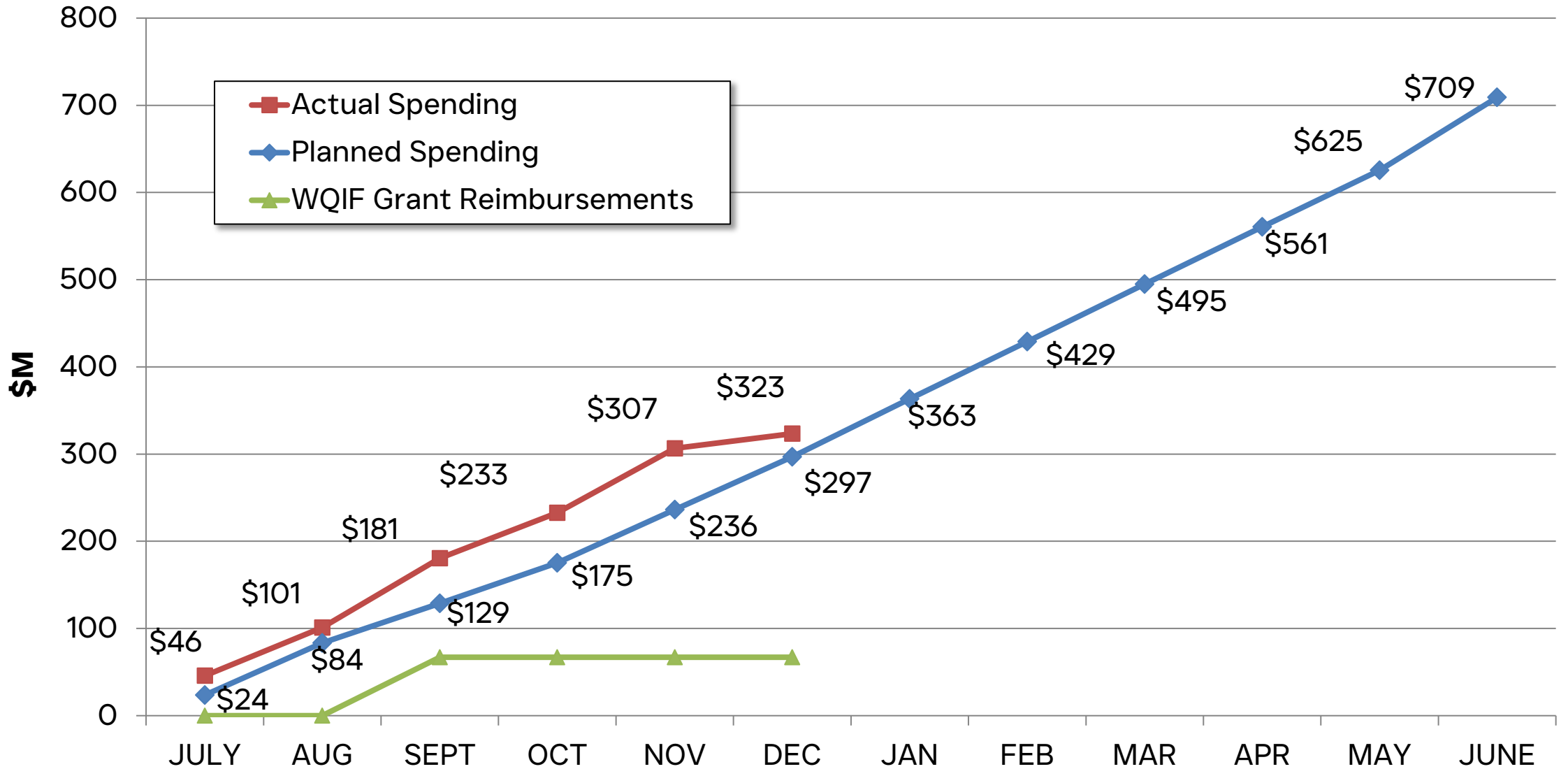

2025 CIP Stats, Spending, and Staffing

- CIP Spending = \$760M across 146 active projects
- Internal Staffing
 - D&C Departments: 25 Full-Time
- External Staffing
 - Augmented: 20 FTEs
 - Consultants: 630 FTEs
 - Contractors: 2,375 FTEs
- **Total: 3,050 FTEs**



2025 Construction Bids

7 Projects	Low Bids \$61,268,750	Avg. of Bids \$72,352,928	High Bids \$84,444,886	# Bids 3.4
-------------------	---------------------------------	-------------------------------------	----------------------------------	----------------------

Engineer's Estimates
\$79,460,229

Construction Bid Trends

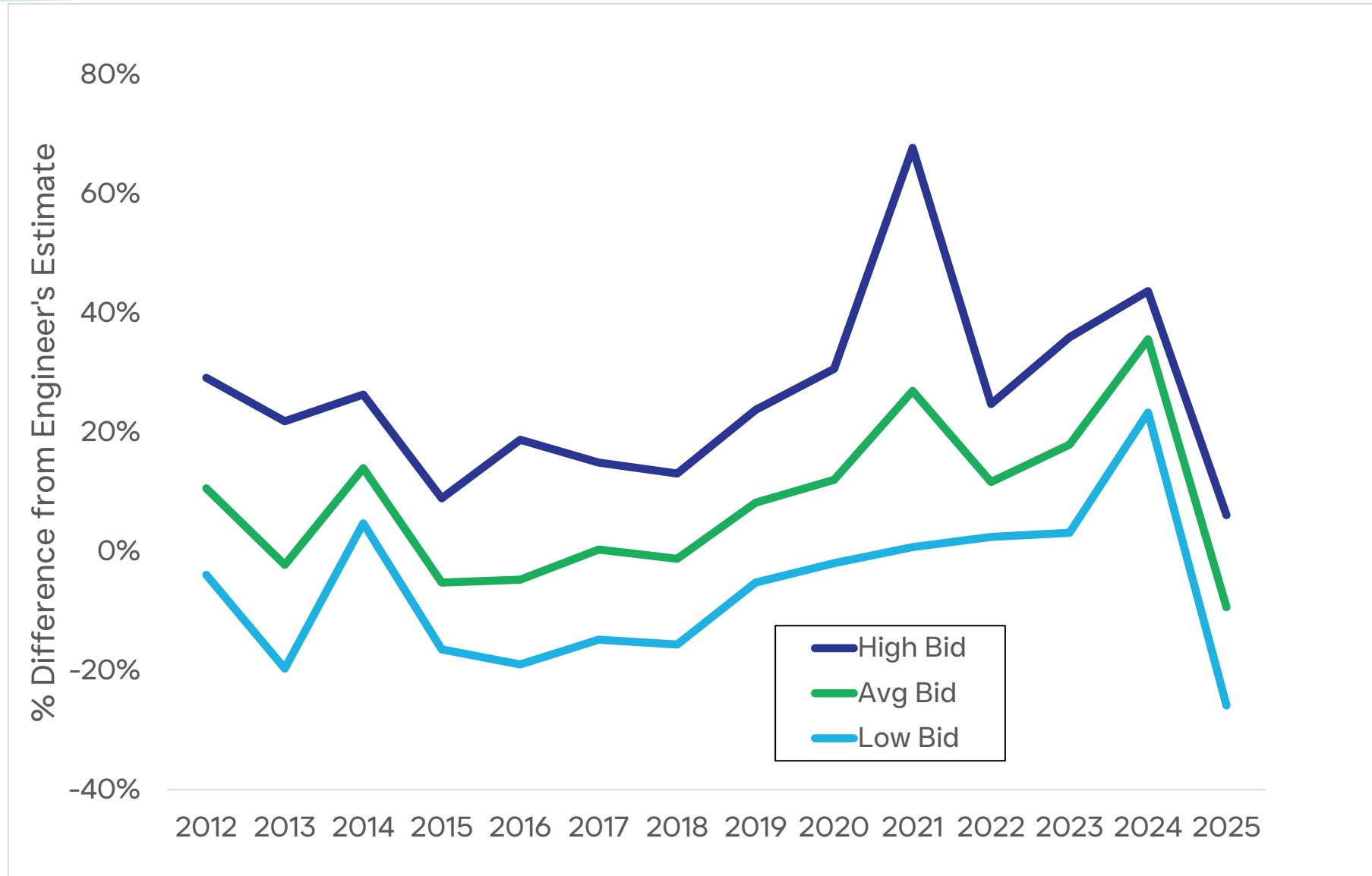

Construction Bid Trends

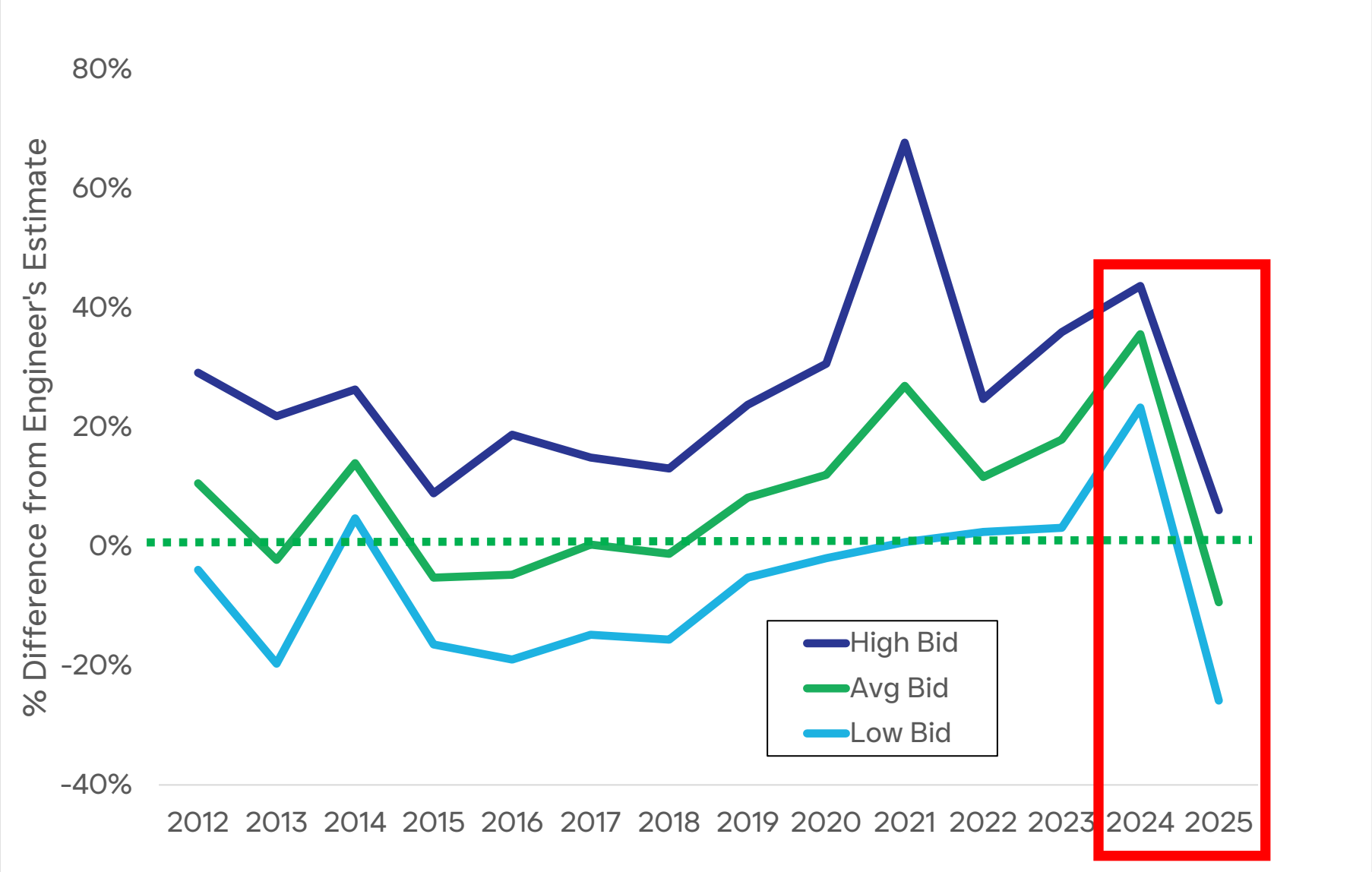

Construction Bid Trends

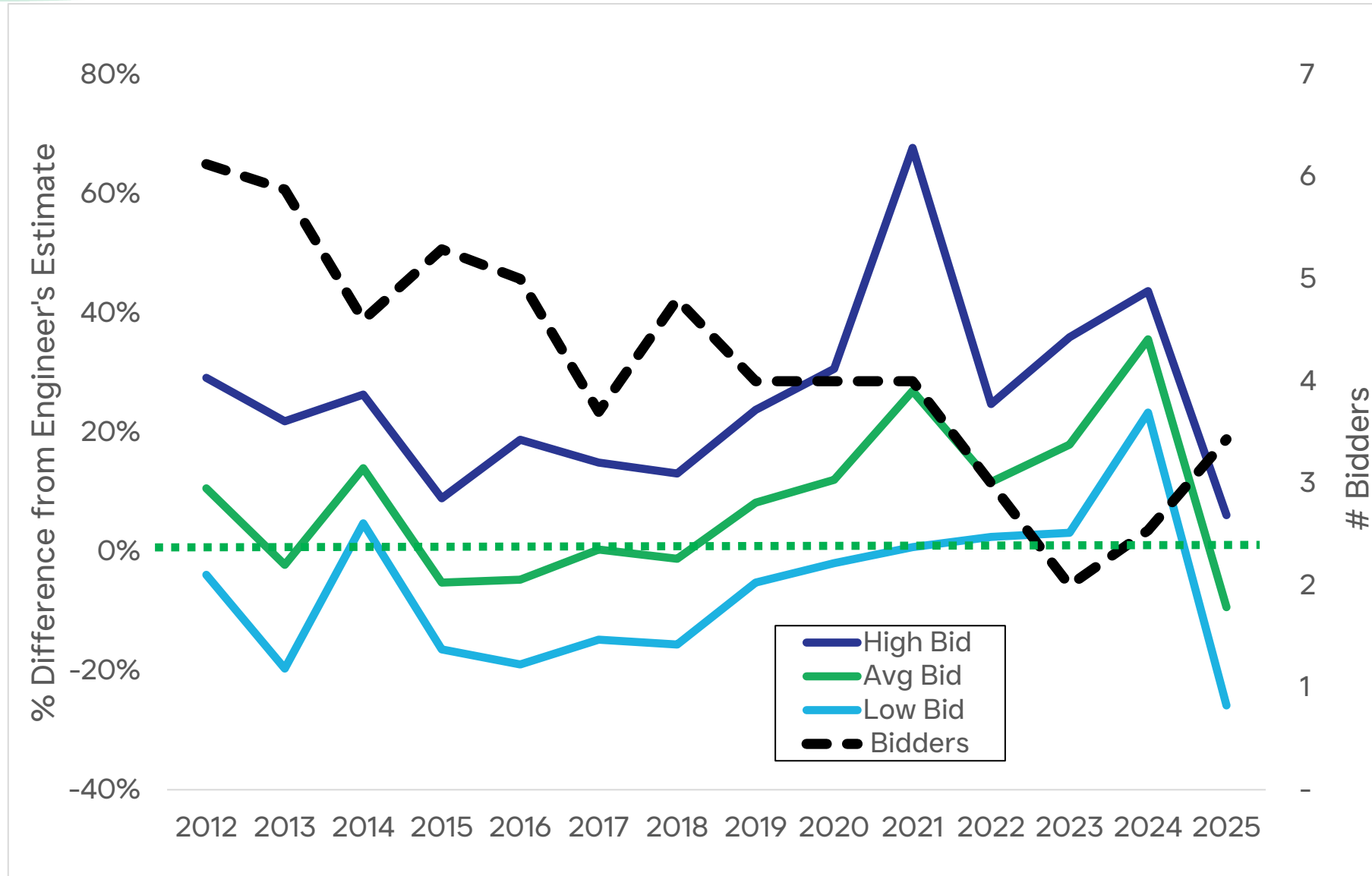

Construction Change Orders

Change Orders - 2013 to Present

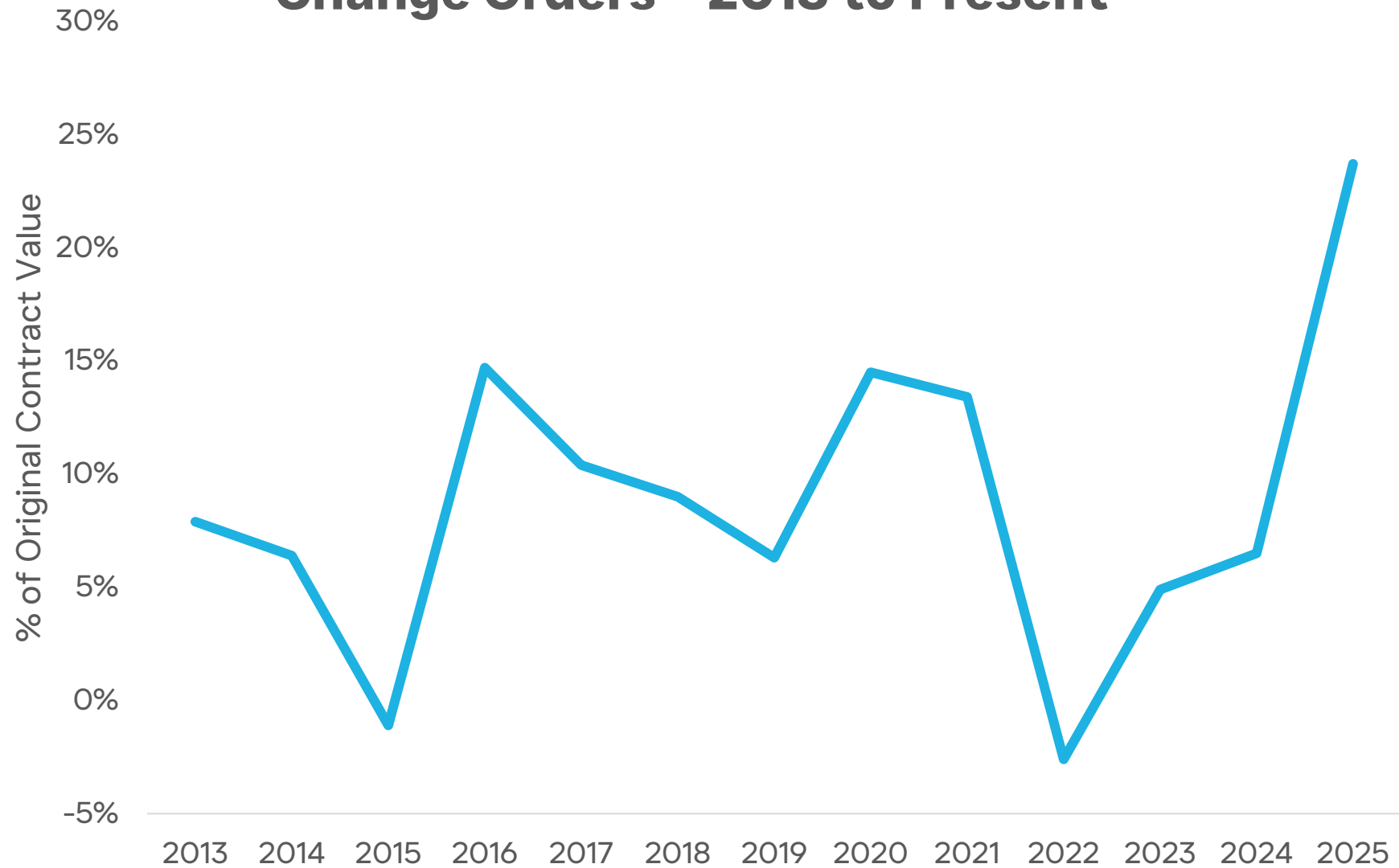

Construction Change Orders

Change Orders – 2013 to Present

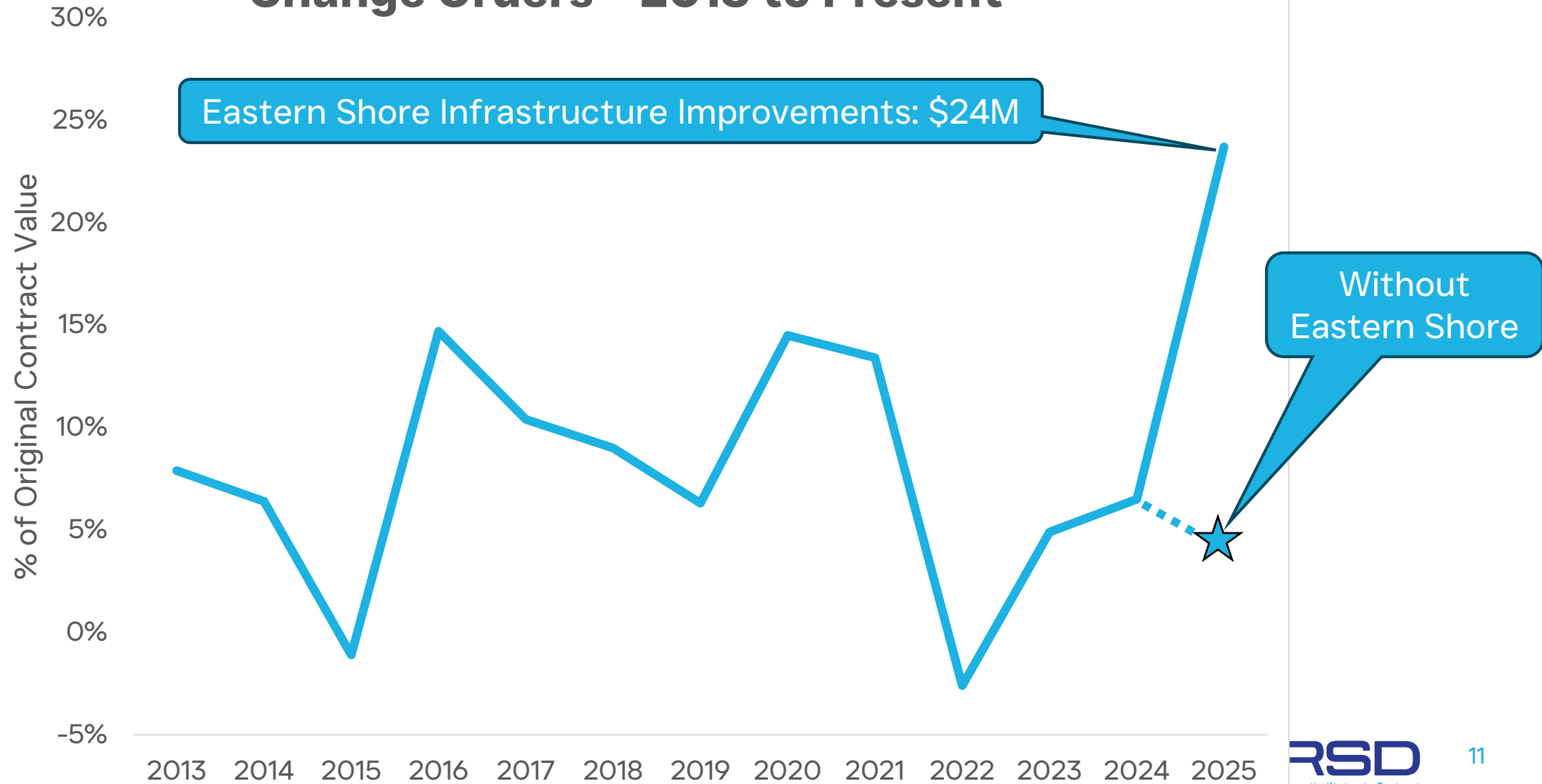

Construction Change Orders

Change Orders – 2013 to Present

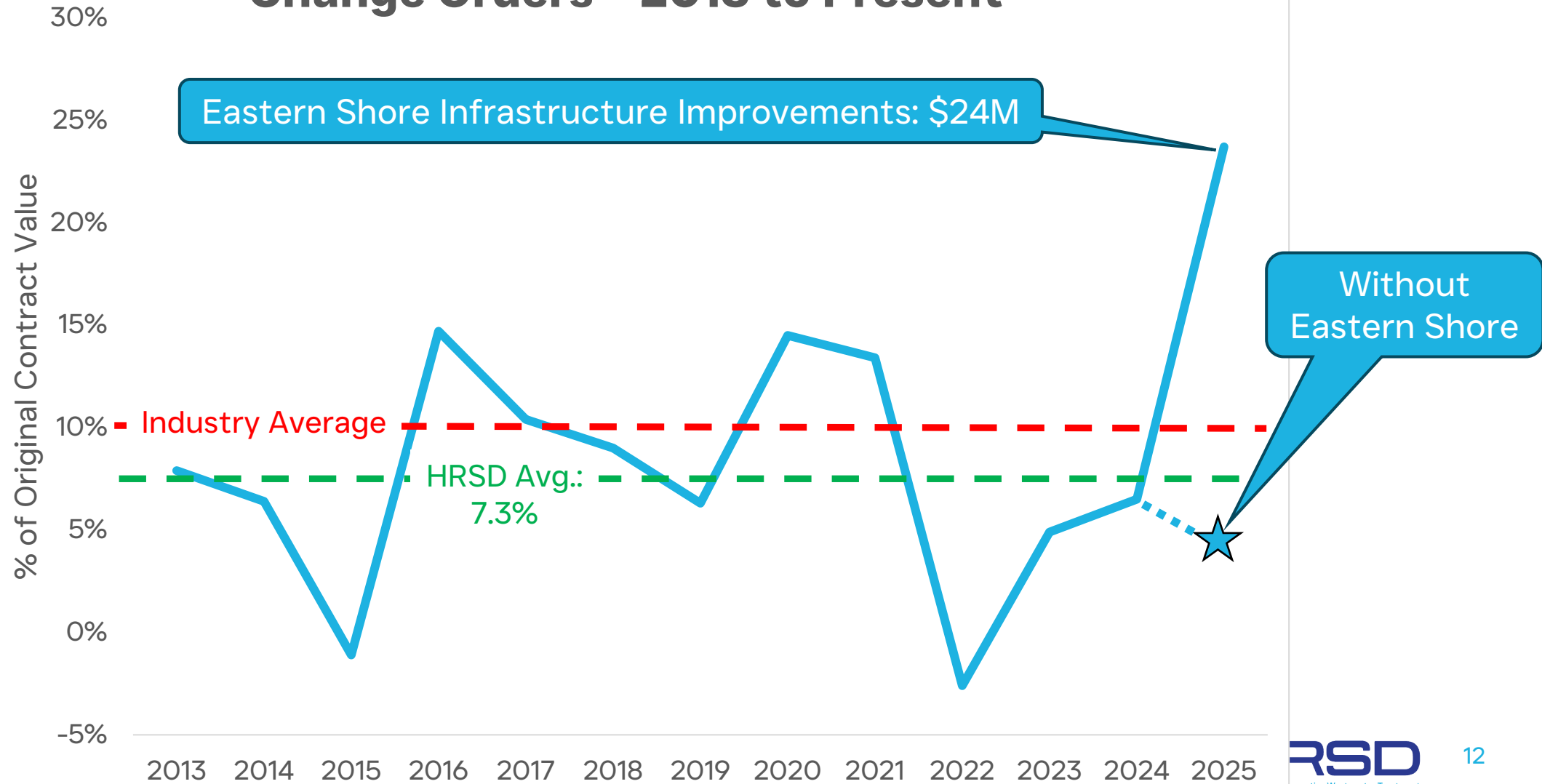

CIP Enhancements

- 2025

- Construction Cost Estimating User Group
- Updated Standards – 3rd party cost estimates and PIC involvement
- Contractor outreach before bids
- 6+ week bid period for WWTP & PS projects
- Industry Outreach page

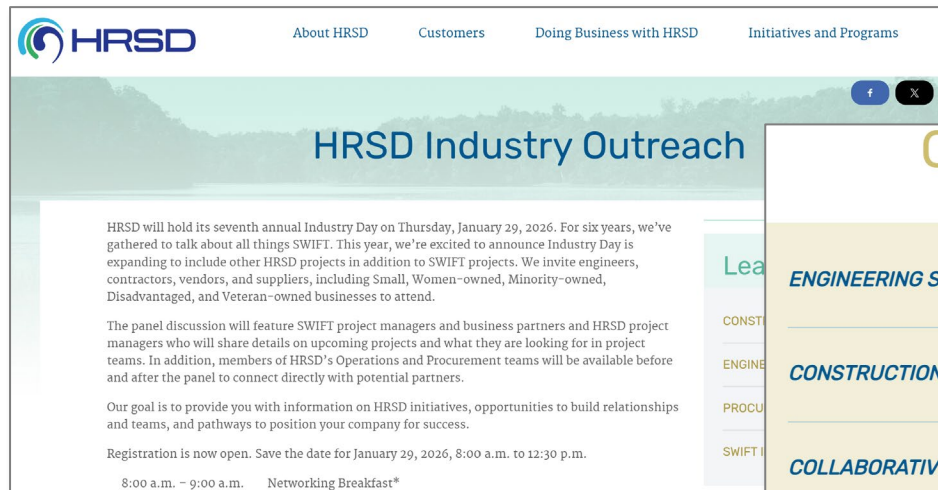

Contract Advertisement Information

- ENGINEERING SERVICES
- CONSTRUCTION CONTRACTS
- COLLABORATIVE DELIVERY CONTRACTS

ENGINEERING SERVICES

CONSTRUCTION CONTRACTS

SECTION W FORCE MAIN REPLACEMENT (AB010500) – ADVERTISE NOVEMBER 2025

Description: This project is to study, design and construct a replacement interceptor for Line SF-006, approximately 2,642 linear feet (LF) of 10-inch cast iron force main that is the discharge line from HRSD's North Shore Road Pump Station. This project will include replacement main line valves, branch valves, associated appurtenances and replace the existing force main through the walls into the pump station.

Project Location: [Map](#)

Anticipated Construction Start-End: January 2026 – April 2027

Key Components:

- 8-inch Ductile Iron (CL-51)
- Approximately 6 feet deep along Shirland Avenue
- Approximately 9 feet deep across W Little Creek Road underneath existing

CIP Enhancements

- 2025
 - Construction Cost Estimating Users Group
 - Updated Standards – 3rd party cost estimates and PIC involvement
 - Contractor outreach before bids
 - 6+ week bid period for WWTP & PS projects
 - Industry Outreach page
- Upcoming
 - Revised CIP appropriation structure
 - PSO Department
 - Improved project reporting processes

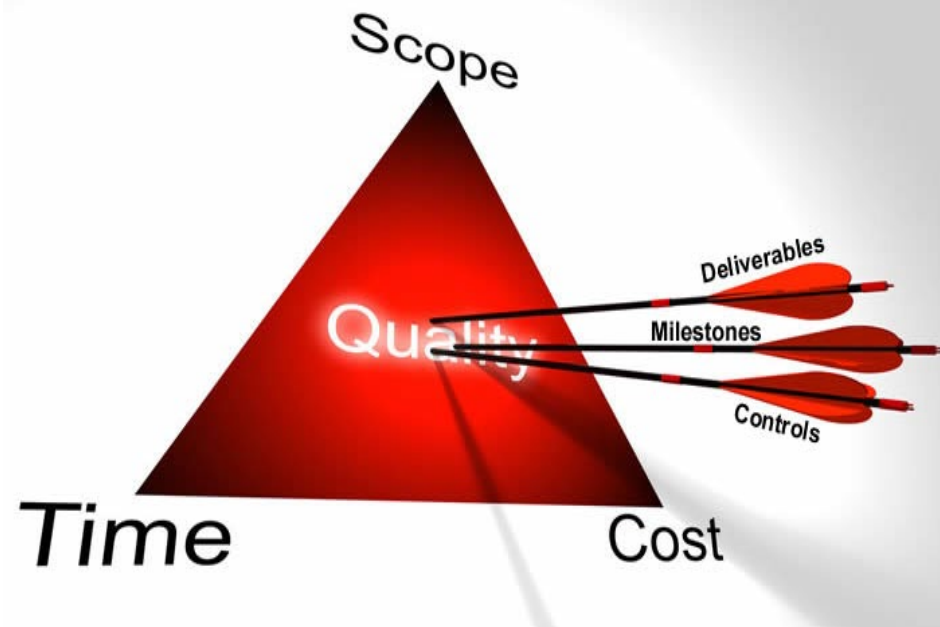

Regulatory Compliance Update

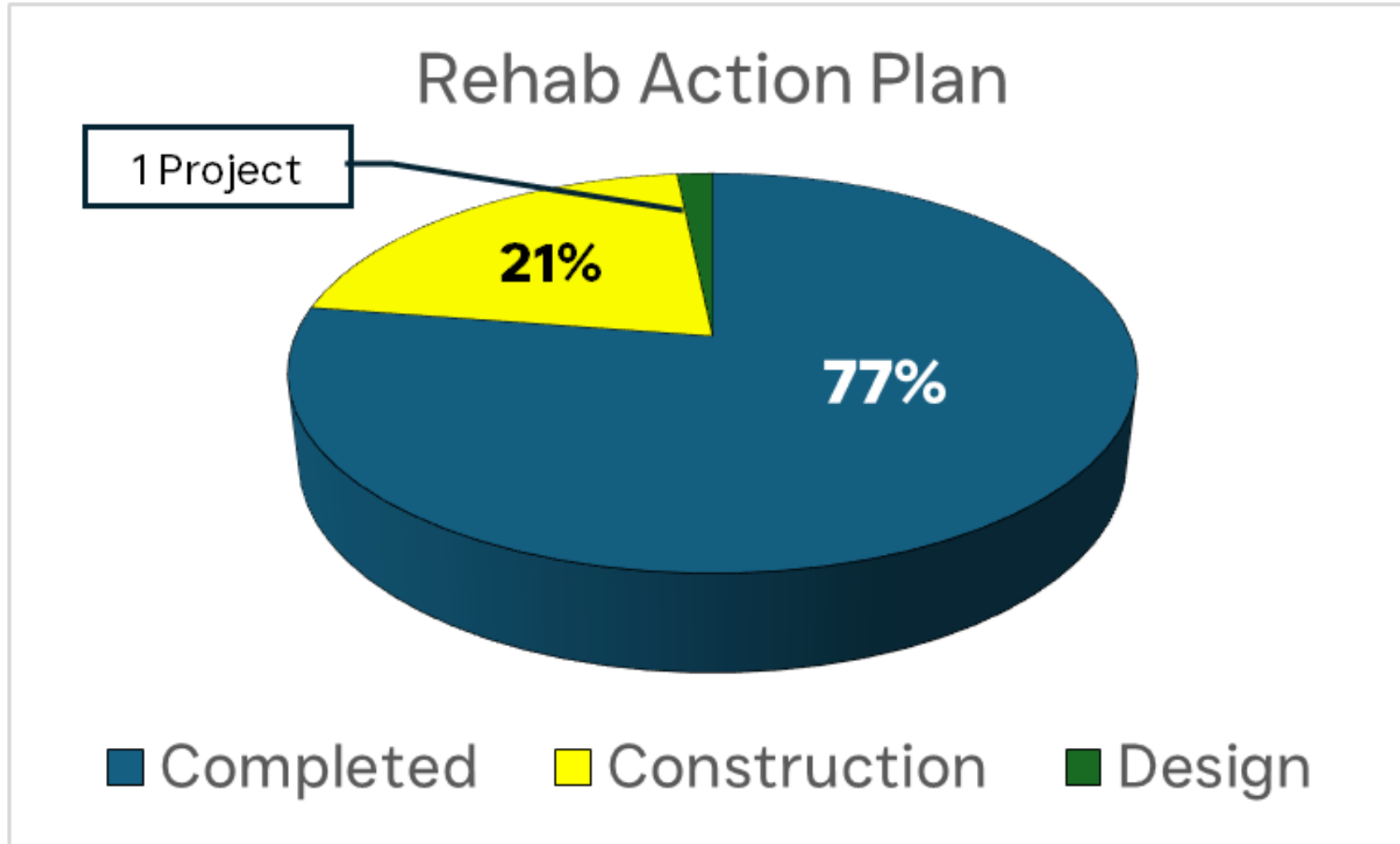

Regulatory Compliance Update

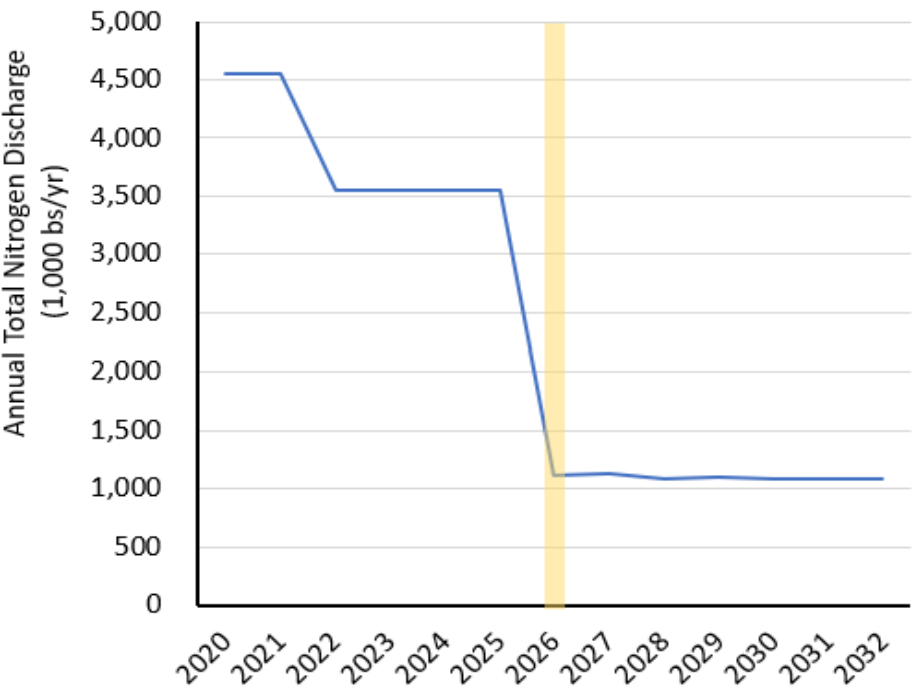
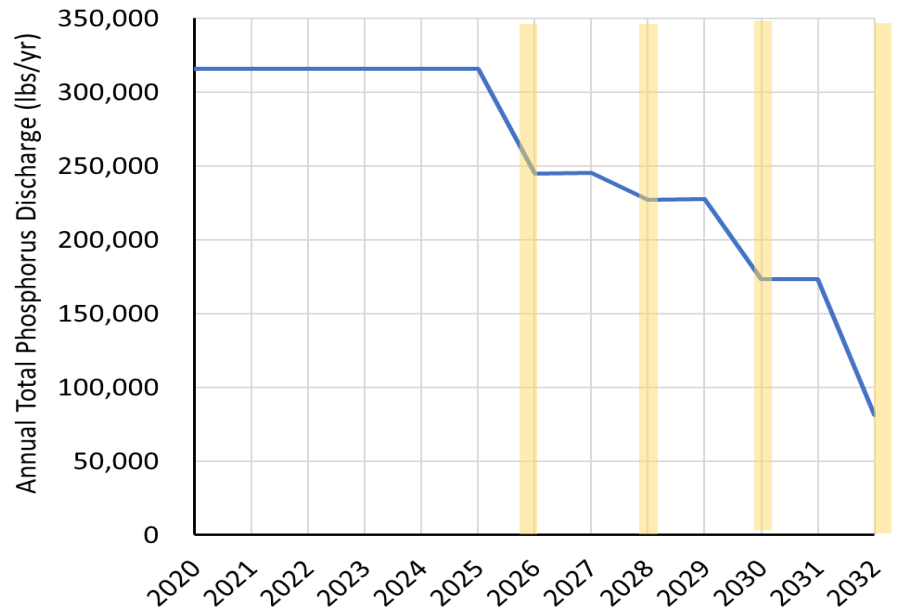

APRIL 2026

Substantial Completion
 BH Pump Station
 BH Force Main 1
 BH Force Main 2
 Nansemond ANRI

October 2026

Final Completion
 BH Pump Station
 BH Force Main 1
 BH Force Main 2
 Nansemond ANRI



**WE ARE
 HERE**



OCTOBER 2026

Substantial Completion
 James River ANRI/SWIFT

Major SWIFT construction progress through CY 2025

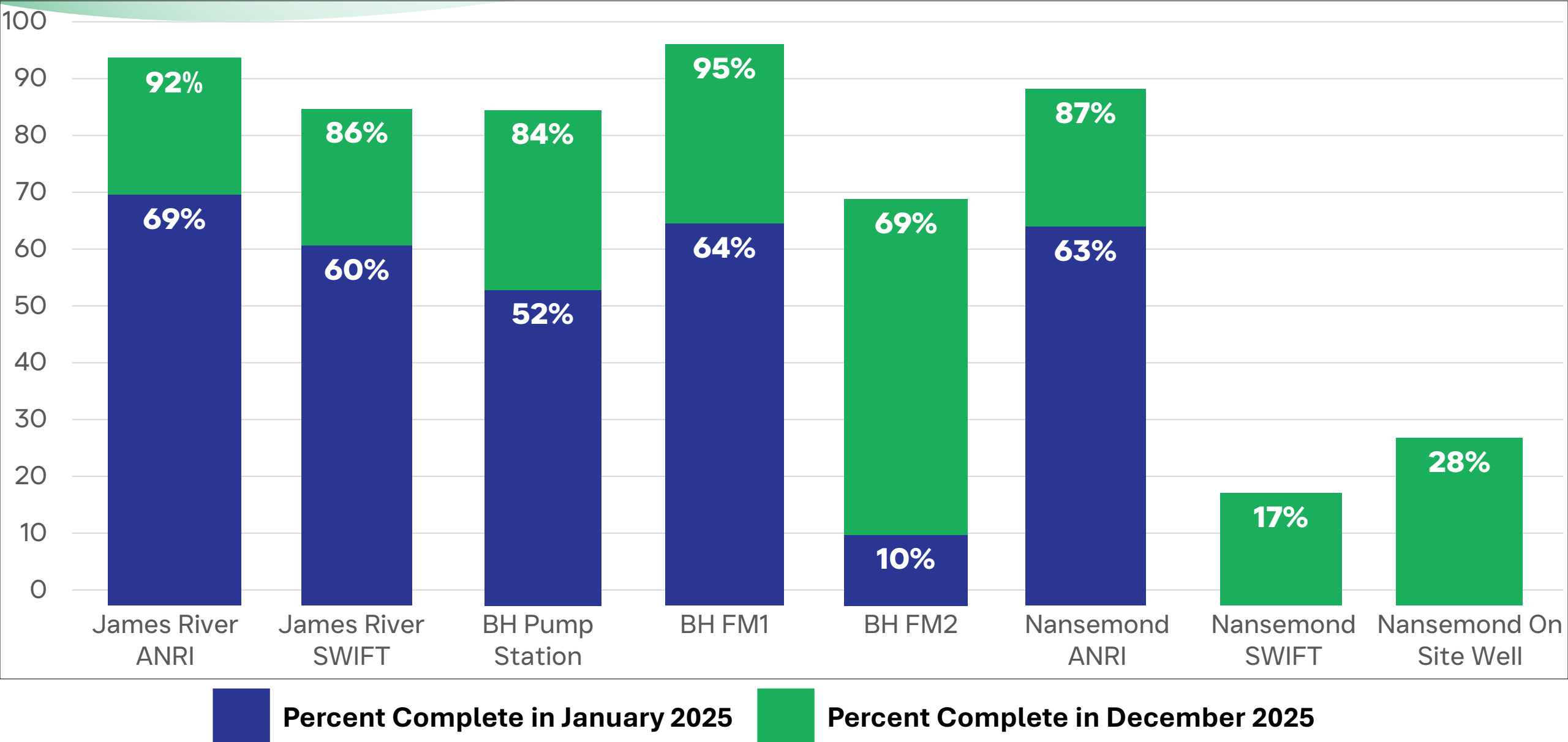

James River Project



Admin complex



Fully commissioned Methanol facility



Installation and wet testing of MBBR media

James River MAR Well Project



Installation of HVAC, plumbing and electrical systems at MAR Wells 1-4 and 7-10



Recharge Well #1



Recharge Well #3



Recharge Well #5



Recharge Well #6

BH Pump Station Project



Screen



Electrical room



Grit removal



Transfer pumps

BH Force Main 2 Project



Microtunnel pipe



Instrumentation vault concrete

Nansemond ANRI Phase II Project



SWIFT partners continue their commitment to the community



Virginia Forever 2025 Bridge Builder

- Monetary donation honoring 2025 Bridge Builders for protecting Virginia’s natural resources.

Book Tagging and Donations

- Employees donated STEM- and construction-themed books for Newport News Public Schools, including notes of encouragement to inspire future builders and support literacy.

Imagine a Day Without Water - SWIFT Research Center Field Trips

- Chaperoned two field trips to the Research Center and provided notebooks for hands-on learning.



Lafayette Park Maintenance

- Partnered with Chesapeake Bay Foundation to remove invasive species, plant vegetation, and restore wetland areas at Lafayette Park.

Mayflower Marathon

- Volunteered with the local foodbank to collect and sort donated food items community members dropped off at the mall.



Minority Business Council (MBC) Conference & Expo

- Networked at the MBC Conference to network with SWaM businesses across Virginia Beach and the region.



High Priority I/I Reduction Program Update

- Sept 2025: Max. Price Agreement (\$143.7M)
 - Locality Meetings/Agreements
 - Cost-Effective Analysis
 - Preliminary Engineering Reports
- Program Packages
 - #1 Program Management (\$14.3M)
 - #2 JCSA Design (\$485K)

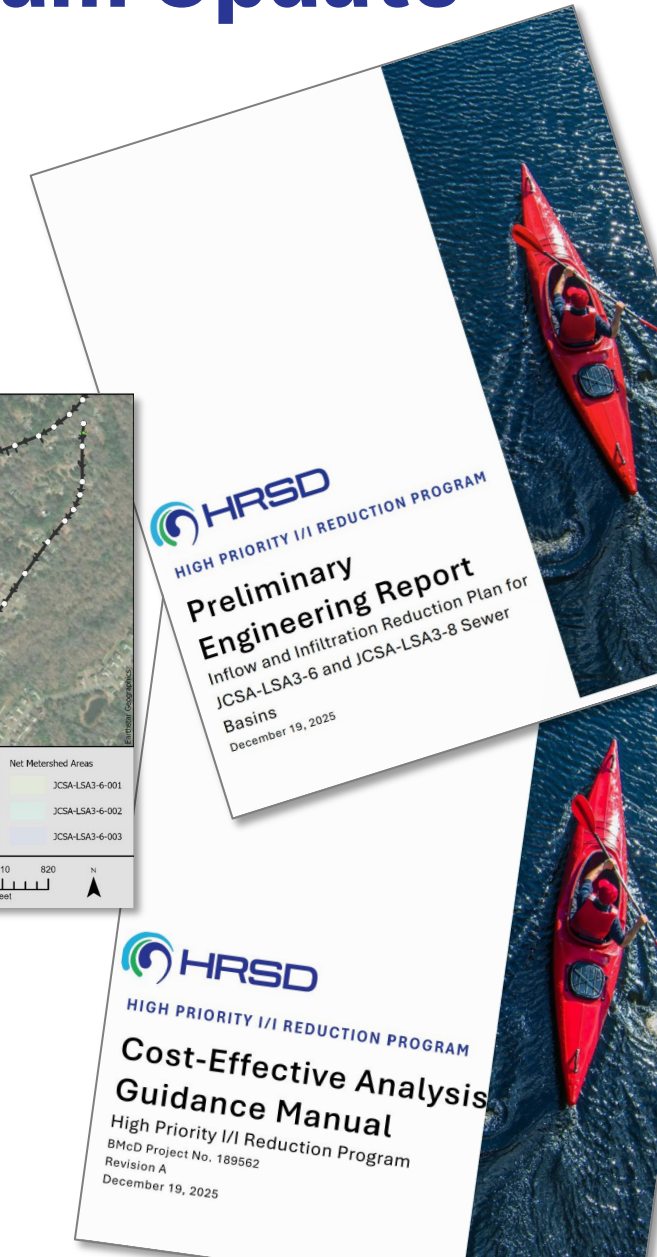
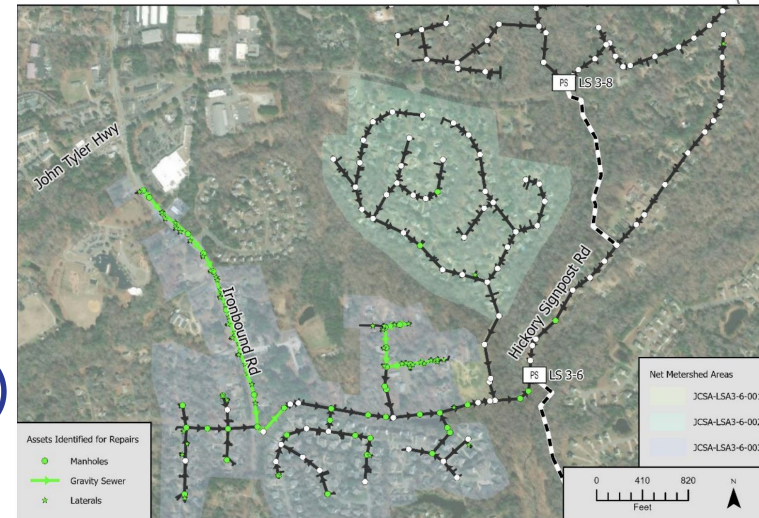

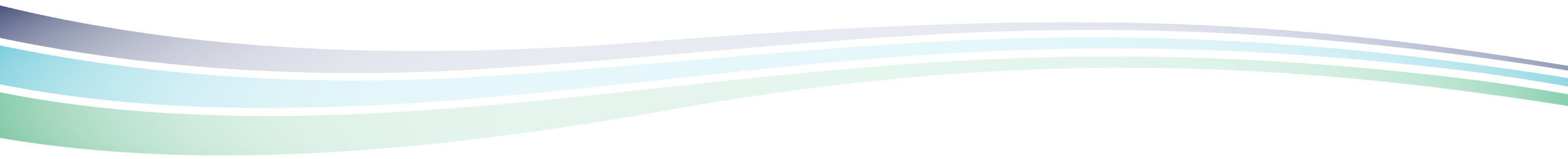

**Project Spotlight:
WBTP Outfall Flow Control
System Repairs (WB013100)**













Questions?

HRSD Commission Meeting Minutes
January 27, 2026
Attachment #8

14. Informational Items

a. Management Reports

- (1) [General Manager](#)
- (2) [Communications](#)
- (3) [Engineering](#)
- (4) [Finance](#)
- (5) [Information Technology](#)
- (6) [Operations](#)
- (7) [Talent Management](#)
- (8) [Water Quality](#)
- (9) [Report of Internal Audit Activities](#)
- (10) [Arrears Payments, Current State Assessment: Summary of Results](#)

b. [Strategic Metrics Summary](#)

January 20, 2026

Re: General Manager's Report



Environmental Responsibility

With our metallic pipes subject to high groundwater, they are susceptible to external corrosion. We are happy to report that our Asset Management team completed their biennial inspections in December.

Treatment Compliance and System Operations: There were multiple events this month and additional details are available in the Air and Effluent Summary in the Water Quality (WQ) monthly report.

- For Fiscal Year (FY) 2026 to date, there have been six Permit Exceedances out of 27,933 Total Possible Exceedances.
- Pounds of Pollutants Removed in FY 2026 to date: 86.3 million pounds.

Water Quality: One civil penalty was issued in December to United Site Services of Maryland dba Russel Reid – Barhamsville. They had three violations for multiple late reports and failure to make a timely response, resulting in a \$2,750 penalty, which was paid in full.



Financial Stewardship

Old Dominion University (ODU) is finalizing the first phase of their SWIFT economic study. Bottom line, HRSD saved the region over \$5 billion with our Integrated Plan compared to each entity trying to comply by themselves. These savings contributed \$3.59 billion to Virginia's GDP and created 28,500 jobs.

Finances continue to look healthy as revenues exceed expenses. Even with persistent inflation, expenses remain under control and below budget halfway through the fiscal year.

Customer Care post-call feedback continues to be high at an 86% favorable rating. Digital outreach continues to be strong as 5,400 payments were attributed to automated text reminders.



Talent

Lauren Zuravnsky was elected to the WateReuse Association's executive board as Secretary. This is a great opportunity given her leadership on the SWIFT program. Jamie Mitchell was elected Secretary/Treasurer for VIRGINIAforever, which is a statewide coalition of businesses, environmental groups, and outdoor enthusiasts that advocates for increased government funding to protect and improve Virginia's water quality and land conservation.

I was elected to the Water Research Foundation (WRF) board in December and will be serving a three-year term. HRSD has 32 active WRF research projects, the most in the country, so this is a great opportunity.

Turnover excluding retirements continues to be low at 2.3% fiscal year to date. Staffing levels remain relatively high at 93% as 18 positions were filled in the last month.

In an effort to help more young folks in the water sector, Patrick Porto, South Shore Interceptor Operations Inspector, presented HRSD career opportunities at the Virginia Beach Technical and Career Education Center, including providing a demonstration building a closed-loop PVC system to simulate plant work.

HRSD launched a new recognition platform from Awardco. Awardco is a modern employee recognition and rewards platform that helps organizations build a culture of appreciation by letting managers and peers celebrate achievements and milestones with meaningful rewards. It integrates with existing HR systems and offers points that employees can redeem for a huge range of options—boosting engagement, retention, and performance. The platform also includes real-time analytics and flexible incentive programs to drive measurable results across the workforce.

HRSD's award winning Career Pathways Program, where employees can receive career mapping assistance, continues to show progress. Since May 2025:

- 63 participants engaged
- 101 one-on-one appointments
- 27 interviews, 10 promotions confirmed



Community Engagement

Staff toured New Kent's Parham Landing wastewater treatment plant. We are working on developing a partnership with them to find a win-win to the challenges we are both facing. In addition, we have reached out to Hanover County to engage in similar partnership discussions.

HRSD hired the Gaston Group, led by Susan Gaston, to serve as our regional lobbyist. With 20 locality boards, 23 delegates, and 11 senators within HRSD's service area, having a regionally focused lobbyist will be very helpful on a number of fronts.



Innovation

I attended my quarterly Water Disruption Study Group, which is sponsored by Xylem and led by Radhika Fox, former EPA Assistant Administrator for Water.

HRSD will be piloting Wintec Glovis' Superheated Steam technology to regenerate Granular Activated Carbon (GAC) and comparing it to standard thermal reactivation. Data from the company shows no PFAS in the condensate, which is very promising for our pilot. The 40-foot container is enroute and should be at the SWIFT Research Center by March/April. Wintec Glovis is currently building two large regional regeneration facilities for K-water (South Korea's national water agency), which are much larger than what we would build, so this technology is beyond lab scale and fully engineered.

Chris Burbage, Kenny Hoffman, and April Richardson co-authored a peer-reviewed paper in the Journal of Environmental Management examining PFAS retention and distribution in soils impacted by biosolids application. The research documents PFAS studies conducted at the HRSD Progress Farm in collaboration with Linda Lee and Lynda Pater of Purdue University.

I look forward to seeing you virtually at 9:00 a.m. on Tuesday, January 27, 2026.

Respectfully submitted,

Jay Bernas

Jay Bernas, P.E.
General Manager/CEO

TO: General Manager
FROM: Chief Communications Officer
SUBJECT: Monthly Report for December 2025
DATE: January 13, 2026

A. Publicity and Promotion

1. HRSD and the Sustainable Water Initiative For Tomorrow (SWIFT) were mentioned or featured in 14 stories this month. Topics included:
 - a. HRSD Creating the Silicon Valley of Water Innovation in Coastal Virginia
 - b. Replenishing groundwater could trigger small earthquakes (two stories)
 - c. Senator Stuart Focusing on Water Supply in 2026 General Assembly
 - d. Column in Daily Press about Hampton Roads becoming the world's coastal resilience capital
 - e. Traffic delays associated with emergency repair work in Chesapeake (two stories)
 - f. Business Notes in the Virginian Pilot announcing Commissioner Andrews' appointment

2. Analysis of Media Coverage

a. Key results for December

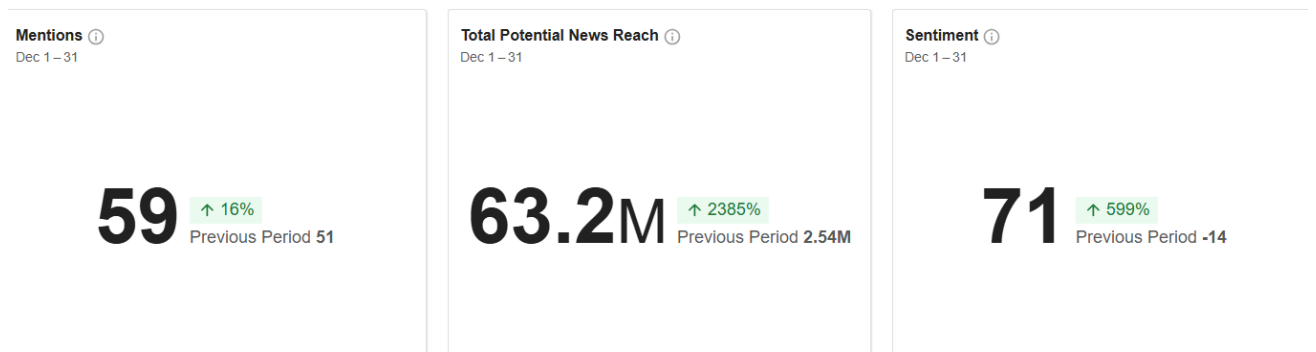

b. Top performing news content

Top Article by Reach

Dec 1 - 31



Yahoo News · Valenti Govantes
Editorial | US | Dec 28, 2025 · 11:50 AM

Lanes at Cedar Road and Country Club Boulevard in Chesapeake to close for emergency sewer repairs

Boulevard in Chesapeake due to emergency sewer repairs, according to **Hampton Roads Sanitation District**. As crews work, Cedar Road's outside

Social Echo 0 0 0
55M Reach

Neutral

Top Article by Social Echo

Dec 1 - 31



Science.org
Editorial | US | Dec 11, 2025 · 12:59 AM

Replenishing sapped groundwater could trigger small earthquakes

silts and sands beneath southeastern Virginia. Next year, the **Hampton Roads Sanitation District** (HRSD) will begin to inject about 60 million

Social Echo 48 11 0
3.25M Reach

Neutral

Top Article by Reach and Volume

Dec 1 - 31



AI Bawaba Business · TTGT
Editorial | JD | Dec 6, 2025 · 2:00 PM

Chemtrac System Parts - Ss Elect

ss elect Major organization : **HAMPTON ROADS SANITATION DISTRICT** Address : **Hampton Roads Sanitation District**. 757-460-7311. Caitlin Geer

Social Echo 0 0 0
5,08k Reach

Neutral

c. Top entities and keywords

Top Entities

Dec 1, 2025 - Dec 31

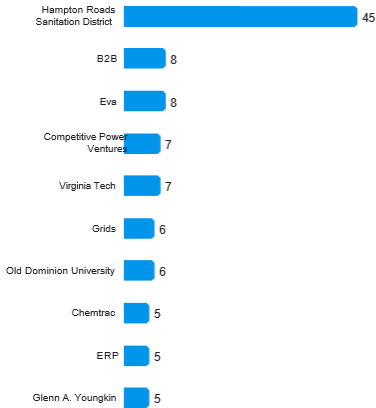

Top Keywords

Dec 1, 2025 - Dec 31



Top Organizations and Share of Voice

Dec 1, 2025 - Dec 31

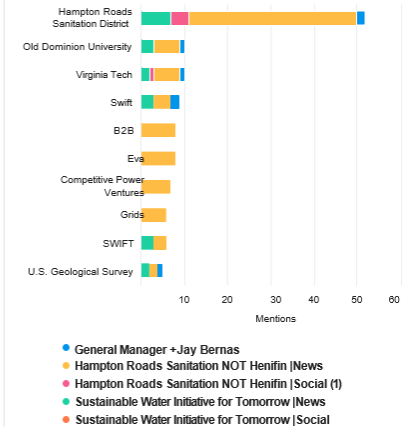

d. How favorable is the content?

Sentiment Share of Voice
Dec 1, 2025 - Dec 31

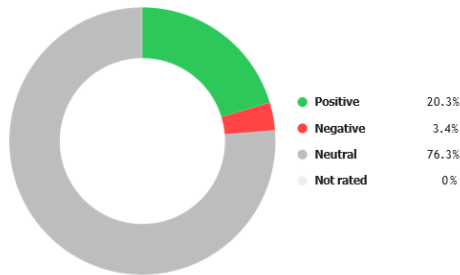

Sentiment by Source Type
Dec 1, 2025 - Dec 31

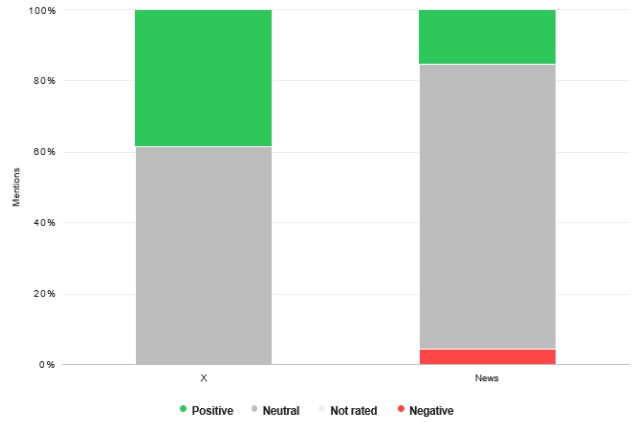

(Negative sentiment directly attributed to HRSD associated with cyber incident and to a letter to the editor in Cape Charles Mirror incorrectly citing “pumping chicken litter into our lower aquifers”)

e. What is the potential reach?

Share of Voice by Reach
Dec 1, 2025 - Dec 31

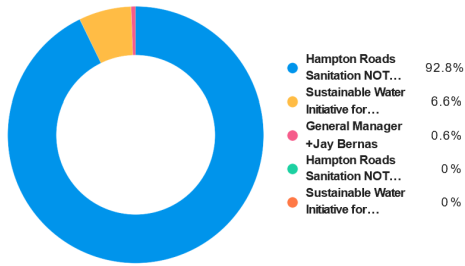

Potential News Reach
Dec 1, 2025 - Dec 31

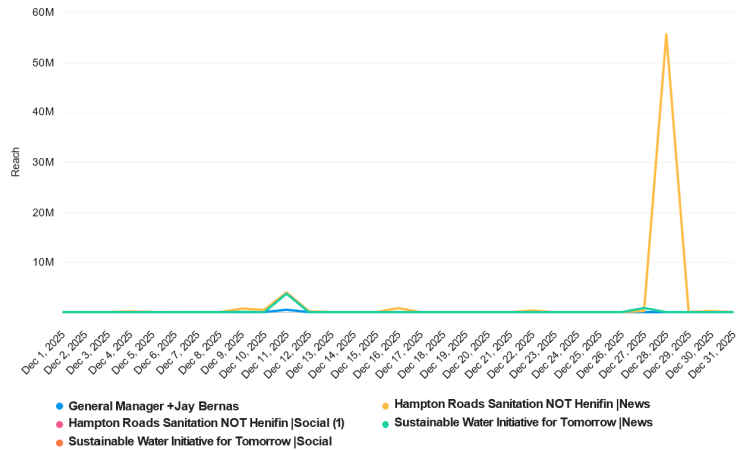

f. Top publishers

Top Publications by Mentions

Dec 1, 2025 - Dec 31

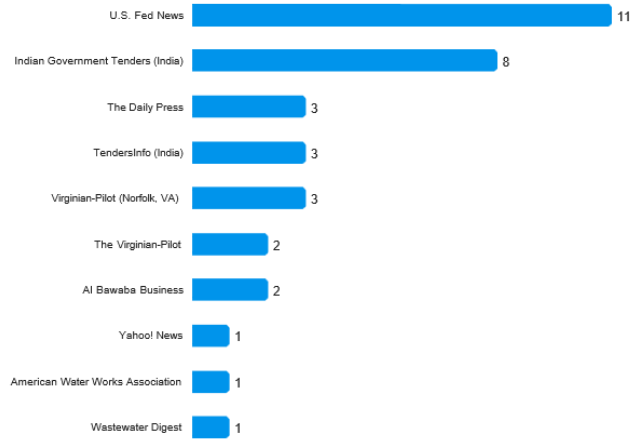

Top Publications by Editorial Reach

Dec 1, 2025 - Dec 31

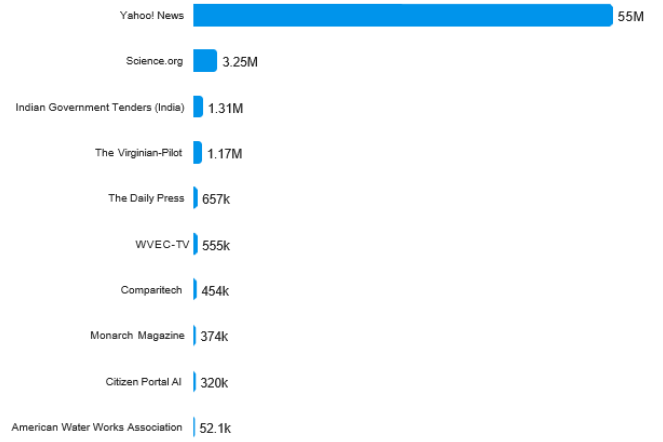

B. Social Media and Online Engagement

1. Metrics – Facebook, X and LinkedIn

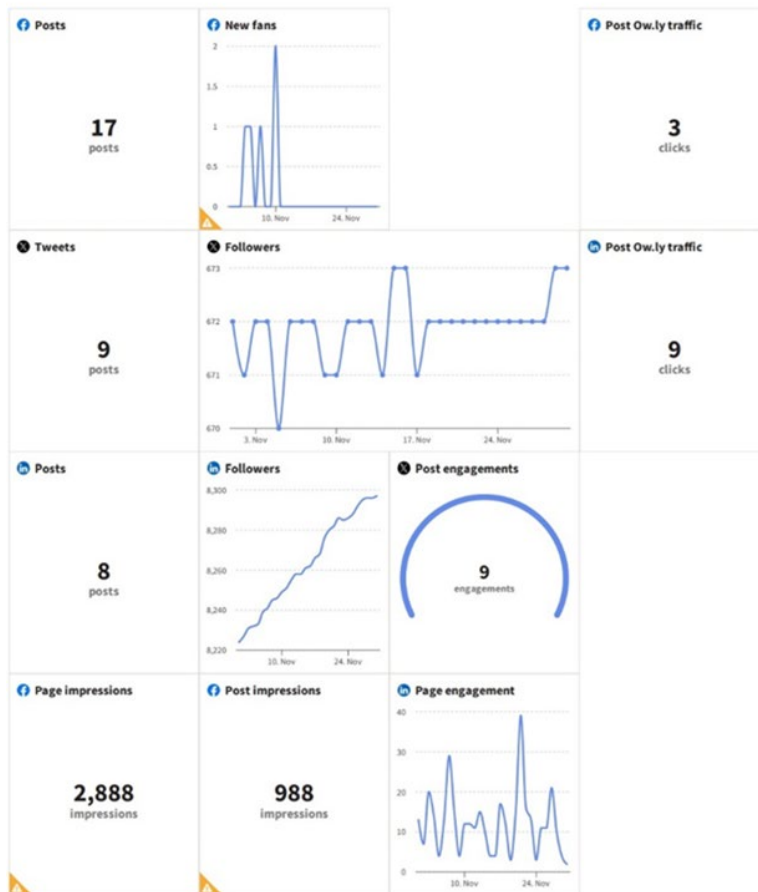

2. YouTube

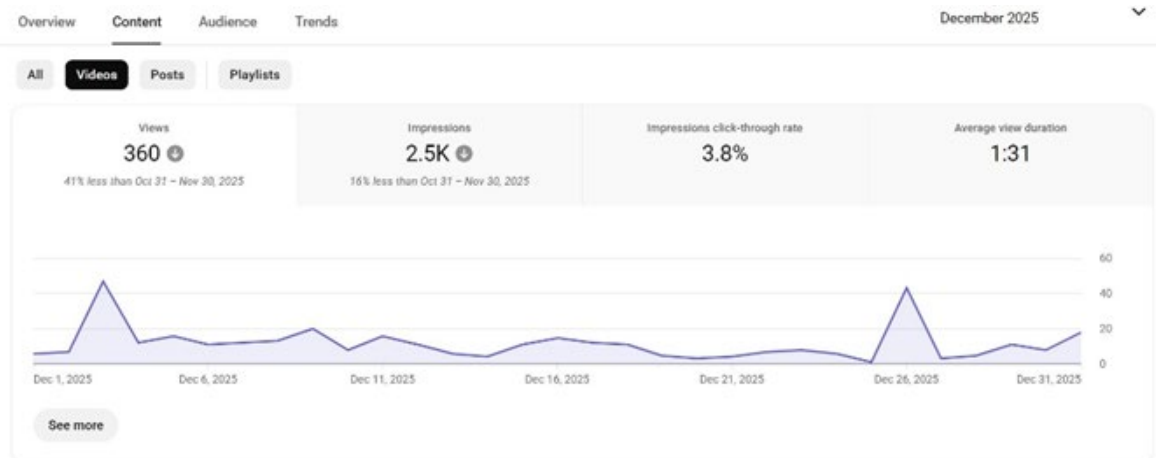

3. Top posts on Facebook, Twitter, and YouTube

a. Top Facebook post

HRSD
Published by Hootsuite · December 5, 2025 at 7:01AM ·

FEATURE FRIDAY! 🎉

We're proud to be featured in CoVaBiz Magazine as part of the region's "Innovation Superheroes", creating the Silicon Valley of water innovation in Coastal Virginia.

This spotlight highlights more than our technology! 💧 It also celebrates the story of how we're engaging with our community and partners to protect local water, support our region, and build a more resilient future.

Read the feature: Guess Who's Creating the Silicon Valley of Water Innovation in Coastal Virginia? <https://ow.ly/jHf850XCGsP>

Guess Who's Creating the Silicon Valley of Water Innovation in Coastal Virginia?
 Hint: It's Not Elon Musk!
 By Beth Heiser

A clean reputation.
 Brought to you by HRSD

CoVaBIZ
 THE BUSINESS MAGAZINE OF COASTAL VIRGINIA
Fired Up!
 Celebrating Our Region's Innovation Superheroes

See insights and ads Boost post

👍 20 5 shares

b. Top LinkedIn Post

HRSD
8,351 followers
3w ·

Pile driving for the deep foundations has begun at the new SWIFT facility at the Nansemond Treatment Plant!
 Find more here <https://ow.ly/bKnn50XGwYm>

👍 Eddie Abisaab and 95 others 1 comment · 1 repost

c. Top X Post



d. Top YouTube Videos (based on views in the month)

- (1) [The Wastewater Treatment Process](#)
- (2) [Hampton Roads Clean Water Cycle](#)
- (3) [Atlantic Treatment Plant Cambi Tour](#)
- (4) [My Account Portal](#)
- (5) [SWIFT Industry Day 2025](#)

4. Website and Social Media Impressions and Visits

a. Facebook:

- (1) 7,143 users
- (2) Facebook Engagement of 176 (162 reactions, 10 shares, and 4 comments)

b. X: 4.4% engagement rate

- c. HRSD.com/SWIFTVA.com: 873 page visits
- d. LinkedIn Impressions:
 - (1) 17,097 page impressions
 - (2) 14,870 post impressions
- e. YouTube: 360 views
- f. NextDoor unique impressions: 8,664 post impressions from 14 targeted neighborhood postings and one regionwide posting.
- g. Blog Posts: (0)
- h. Construction Project Page Visits – 1,610 total

C. Education and Outreach Activity Highlights

1. 12/04/25 – SWIFT Research Center (SWIFT RC) tour for TCC Geology Class
2. 12/04/25 – SWIFT RC tour for HRSD employees, friends and family
3. 12/10/25 – SWIFT RC tour for Cape Henry Collegiate Social Entrepreneurship cohort
4. 12/10/25 – Coordinated “Washing Water” activity that was presented by Chief Engineer to ForKids middle school students
5. 12/15/25 – Larchmont Civic League - construction progress update presentation
6. 798 door hangers and/or mailed letters distributed to residents in communities surrounding six ongoing projects
7. Newsroom postings:
 - a. Construction notices – 4
 - b. News releases – 0
 - c. Traffic Advisories - 4

D. Internal Communications

CCO participated in the following internal meetings and events:

1. Planning and coordination of MOU signing ceremony event at SWIFT RC
2. HRSD.com weekly redesign meetings

3. HRSD/SWIFT Industry Day 2026 planning meetings
4. SWIFT monthly communications status call
5. Bi-weekly General Manager (GM) briefings
6. Discharge Monitoring Report (DMR), SWIFT Quality Steering Team (QST), and HRSD QST meetings
7. Check-in meetings with Deputy General Manager (DGM)
8. CCO conducted biweekly Communications department status meetings and weekly one-on-one check-in meetings.
9. Staff participated in 22 project progress and/or construction meetings in addition to communication planning meetings with various project managers, plant staff, internal and external stakeholders.



Talent

Professional development activities and pursuits for December:

- South Shore Public Information Specialist put in 4.5 hours of virtual graphic design and visual communications training via LinkedIn learning
- IT Holiday Cyber Awareness training for staff
- North Shore Public Information Specialist applied 13.25 hours to completing National Disaster Recovery Framework (NDRF) and National Response Framework introduction courses

Respectfully,

Leila Rice, APR

Chief Communications Officer

TO: General Manager
FROM: Chief Engineer
SUBJECT: Monthly Engineering Report for December 2025
DATE: January 12, 2026



Environmental Responsibility

- Due to the high groundwater conditions in Hampton Roads, our ductile and cast-iron pipelines are susceptible to both internal and external corrosion. To combat external corrosion, our pipelines are installed with a variety of cathodic protection technologies at key locations. Each of these locations is equipped with a test station to determine the remaining life expectancy of the cathodic protection. These stations are tested every other year. FY25 inspections were completed in December by Asset Management.
- Although we often focus our discussions on the treatment technologies at our wastewater plants, another important component of each plant is the outfall pipe, which is where the effluent enters and mixes with the receiving water body. As part of our Chincoteague Treatment Plant Improvement Project, we are not only replacing the package plant, but also the outfall into Chincoteague Bay. To properly design this new pipe, outfall modeling was performed by our consultant, in coordination with Water Quality staff and the Virginia DEQ. The goal of this modeling was to predict effluent dispersion and dilution and to define the mixing zone to protect sensitive areas and aquatic species. In addition, this area of Chincoteague Bay is relatively shallow; thus, the diffuser at the end of the outfall could be vulnerable to anchors and boat propellers if installed in open water. The modeling allowed us to verify that attaching the diffuser directly to the bulkhead, which minimizes the risk of damage, is acceptable from a water quality standpoint.



Financial Stewardship

- Capital Improvement Program (CIP) spending for the fifth month of FY2026 was above the planned spending target, and annual spending is still above the planned CIP target for the fiscal year.

Capital Improvement Program Spending (\$M)

	Current Period	FYTD
Actual	\$67.2	\$300.0
Plan	\$61.1	\$236.3

- The ENR Construction Cost Index rose by 3.6% in 2025, which is in sharp contrast to the 0.9% increase seen in 2024. This was a result of large wage increases due to the scarcity of skilled construction workers, and the financial liquidity of the infrastructure market fueled by sustained federal funding. The second half of 2025 was particularly volatile, due

in large part to tariffs on iron and steel. Looking forward, the overall construction market will cool off, but infrastructure should stay strong (4.1% growth projected), and data centers will continue to grow by a projected 20%-40%. Labor shortages are predicted to continue; thus, 2026 could see similar CCI increases to 2025.



Talent

- Bruce Husselbee, after serving as Chief Engineer for 20 years, has stepped into the role of Engineer in Residence until he retires on March 31, 2026. Jeff Scarano was promoted to Chief Engineer on January 1, 2026.
- Lauren Zuravnsky was voted onto the WateReuse Association Board's executive track, starting with the secretary position in 2026.
- Staff retention and recruitment remain significant priorities for the Engineering Division. Four open positions are needed to fully staff the Engineering Division:
 - Director of Design & Construction – Special Projects
 - Director of Program Support Office (PSO)
 - Engineering Program Manager (formerly: Hydraulic Analysis Manager)
 - Condition Assessment Inspector

The Condition Assessment Inspector position should be filled in January. Interviews for the Special Projects and PSO Directors are scheduled for the end of January. The Engineering Program Manager position should be filled in the next several months.



Community Engagement

- December is typically a quiet month for community engagement due to the holidays, but several notable engagements were made by Engineering:
 - Lauren Zuravnsky and the HRSD Project Manager for James River SWIFT were interviewed by ENR Magazine.
 - Planning efforts for the annual SWIFT Industry Day were in full swing. To date, nearly 350 people are registered to attend, with nearly half of these being first-time attendees. In addition, this year's event will be a hybrid of SWIFT and HRSD Industry Day, with five non-SWIFT projects being highlighted. Over the next several years, this event will transition completely to "HRSD Industry Day" as the large SWIFT projects are completed.
 - Cape Henry Collegiate students and faculty were given a tour of the SWIFT Research Center by HRSD staff and a tour of the Nansemond Treatment Plant construction site by MEB staff.

- HRSD staff met virtually with a group of Hampton University undergraduate students who are working on a senior design project focused on advanced water treatment using ozone.



Innovation

- Through the SWIFT Program, HRSD has been working closely with the USGS for the installation of an extensometer at the James River Treatment Plant. While the typical design for these types of installations includes a single extensometer, the James River extensometer will contain three, each drilled to a different depth. These three extensometers will allow a better understanding of how various layers of soil below the surface respond during recharge. The pilot hole for the third and shallowest extensometer was completed in December.

A handwritten signature in black ink, appearing to read 'J. Scarano', followed by a horizontal line.

Jeff Scarano, PE, BCEE, DBIA

TO: General Manager/CEO
 FROM: Deputy General Manager and Chief Financial Officer
 SUBJECT: Monthly Report for December 2025
 DATE: January 12, 2026



Financial Stewardship

Debt and Grants Management

Staff continued managing active grant awards, including over \$165.9 million in pending WQIF reimbursements, two Community Flood Preparedness projects, and the DEQ Septic-to-Sewer program.

Accounting & Interim Financial Reports

The Operating Fund Interim Financial Report shows that both revenues and expenses are generally in line with the amended budget at midyear.

Although billed consumption—HRSD’s largest revenue driver—continues to come in slightly below budget projections, overall revenue performance remains materially consistent with

expectations. Staff reviewed billed consumption by jurisdiction and observed that in jurisdictions where consumption is lower compared to prior fiscal years, the variances appear to be consistent with known factors. These include significant meter replacement projects, the installation and upgrade of new meters, and billing delays resulting from meter reader staffing shortages.

Strong investment performance and the continue availability of invested bond proceeds continue to bolster interest income which has already reached 97 percent of the annual budgeted amount. Overall total year-to-date revenues total 51 percent of budget, expectations.

Operating expenses appear to be well managed and are only 41 percent of the annual budget authorization.

Month	Summary of Billed Consumption (,000s ccf)						
	FY2026 Cumulative Budget Estimate	% Difference		% Difference		Cumulative 3 Year Average	% Difference From 3 Year Average
		FY2026 Cumulative Actual	From Budget	Cumulative FY2025 Actual	From FY2025		
July	4,723	4,536	-3.9%	4,630	-2.0%	4,605	-1.5%
Aug	9,735	9,205	-5.4%	9,518	-3.3%	9,534	-3.4%
Sept	14,331	13,682	-4.5%	14,223	-3.8%	14,132	-3.2%
Oct	18,841	18,219	-3.3%	18,870	-3.4%	18,801	-3.1%
Nov	22,973	22,425	-2.4%	23,421	-4.3%	23,067	-2.8%
Dec	27,367	26,490	-3.2%	27,666	-4.3%	27,309	-3.0%
Jan	31,942	-	N/A	32,016	N/A	31,835	N/A
Feb	35,907	-	N/A	35,801	N/A	35,861	N/A
March	40,149	-	N/A	40,246	N/A	39,959	N/A
Apr	44,110	-	N/A	44,404	N/A	44,064	N/A
May	48,484	-	N/A	48,830	N/A	48,554	N/A
June	53,000	-	N/A	53,606	N/A	53,120	N/A

Capital activity continued at a strong pace, with \$391.3 million in cash disbursements and \$67.0 million in grant receipts, reflecting sustained progress on major capital projects.

Customer Care

Past due account balances declined in December, particularly in the 31–60 day category, reflecting expected recovery following the federal government shutdown. Field operations delivered 4,478 warning notices and completed 1,519 service disconnections, with reduced activity due to holiday closures. Call volumes averaged 3,250 interactions per week before year-end holidays. Customer feedback from post call surveys remained strong with an 86 percent favorable rating. Digital outreach continues to prove to be effective, generating over 5,400 payments through automated text reminders.

A. Entity Wide Interim Financial Report & Summary of Reserves

Hampton Roads Sanitation District Interim Financial Report Funds Analysis For the Period Ending December 31, 2025

	Operating Fund	Capital Fund	Total
Inflows			
Wastewater Treatment Charges	\$ 252,484,840	\$ -	\$ 252,484,840
Interest Income	9,967,116	960,060	10,927,176
Grants	-	67,001,733	67,001,733
Debt Issuances	-	287,390,456	287,390,456
Transfers-In	-	86,550,673	86,550,673
Total Inflows	262,451,956	441,902,922	704,354,878
Outflows			
Operational	118,513,060	-	118,513,060
Debt Service	55,947,302	-	55,947,302
Capital	-	391,268,248	391,268,248
Transfers-Out	86,550,673	-	86,550,673
Total Outflows	261,011,035	391,268,248	652,279,283
Net Change in Reserves	1,440,921	50,634,674	52,075,595
Beginning Reserves	287,822,081	315,786,765	603,608,846
Ending Reserves	\$ 289,263,002	\$ 366,421,439	\$ 655,684,441
Ending Reserves Summary			
Unrestricted			
General	\$ 246,754,447	\$ 449,558	\$ 247,204,005
Risk	4,799,555	-	4,799,555
PayGo	-	234,219,458	234,219,458
Total Unrestricted Reserves	251,554,002	234,669,016	486,223,018
Restricted			
Debt Service	37,709,000	-	37,709,000
Bond Proceeds	-	131,752,423	131,752,423
Total Ending Reserves	\$ 289,263,002	\$ 366,421,439	\$ 655,684,441

Notes to Entity Wide Interim Financial Report and Summary of Reserves

The Entity Wide Interim Financial Report and Summary of Reserves summarizes the results of HRSD's operations and capital improvements on a basis of accounting that differ from generally accepted accounting principles. Revenues are recorded when received and expenses are generally recorded when paid. No provision is made for non-cash items such as depreciation and bad debt expense.

Reserves represent the balance of HRSD's cash and investments classified into functional purposes.

B. Operating Fund Interim Financial Report - Budget to Actual

Hampton Roads Sanitation District
Operating Fund Interim Financial Report
Budget to Actual
For the Period Ending December 31, 2025

	Amended Budget	Current YTD	Current YTD as % of Budget (50% Budget to Date)	Prior YTD as % of Prior Year Budget
Operating Revenues				
Wastewater	\$ 486,718,000	\$ 239,487,603	49%	52%
Surcharge	1,568,000	707,850	45%	61%
Indirect Discharge	3,526,000	2,466,634	70%	55%
Fees	4,560,000	2,293,872	50%	63%
Municipal Assistance	734,000	358,673	49%	39%
Miscellaneous	808,000	595,375	74%	36%
Total Operating Revenue	497,914,000	245,910,007	49%	52%
Non Operating Revenues				
Facility Charge	6,620,000	3,545,480	54%	56%
Interest Income	11,500,000	11,101,735	97%	178%
Other	1,545,000	1,269,735	82%	132%
Total Non Operating Revenue	19,665,000	15,916,950	81%	122%
Total Revenues	517,579,000	261,826,957	51%	54%
Transfers from Reserves	26,039,871	13,019,935	50%	50%
Total Revenues and Transfers	\$ 543,618,871	\$ 274,846,892	51%	54%
Operating Expenses				
Personal Services	\$ 86,931,718	\$ 42,424,300	49%	48%
Fringe Benefits	31,351,107	15,026,057	48%	44%
Materials & Supplies	16,542,501	6,562,828	40%	47%
Transportation	2,679,992	883,353	33%	37%
Utilities	18,037,260	7,351,007	41%	46%
Chemical Purchases	19,158,847	6,656,364	35%	39%
Contractual Services	62,040,179	21,472,557	35%	33%
Major Repairs	18,968,701	5,263,179	28%	20%
Capital Assets	2,280,197	910,987	40%	8%
Miscellaneous Expense	4,527,025	2,074,484	46%	63%
Total Operating Expenses	262,517,527	108,625,116	41%	41%
Debt Service and Transfers				
Debt Service	108,000,000	55,947,302	52%	57%
Transfer to CIP	173,101,344	86,550,672	50%	50%
Total Debt Service and Transfers	281,101,344	142,497,974	51%	53%
Total Expenses and Transfers	\$ 543,618,871	\$ 251,123,090	46%	47%

Notes to Operating Fund Interim Financial Report – Budget to Actual

The Operating Interim Financial Report – Budget to Actual is intended to summarize financial results on an accounting basis similar to the Annual Operating Budget. The basis of accounting differs from generally accepted accounting principles and from the Entity Wide Interim Financial Report. Revenues are recorded on an accrual basis, whereby they are recognized when billed, and expenses are generally recorded on a cash basis. No provision is made for non-cash items such as depreciation and bad debt expense.

C. Capital Fund – Project Length Summary of Activity

HRSD-PROJECT ANALYSIS

December 31, 2025

Classification/ Treatment Service Area	Appropriated Funds	Project to Date Expenditures	Encumbrances	Available
Administration	\$ 140,401,101	\$ 54,958,564	\$ 64,731,264	\$ 20,711,273
Army Base	171,571,945	134,197,298	5,158,355	32,216,292
Atlantic	226,701,479	64,419,319	40,748,907	121,533,253
Boat Harbor	507,365,299	378,218,268	74,433,734	54,713,297
Ches-Eliz	29,279,118	14,332,942	1,768,341	13,177,835
Eastern Shore	68,576,326	46,426,938	2,243,543	19,905,845
James River	365,719,212	306,398,401	27,061,086	32,259,725
Middle Peninsula	102,413,061	23,430,005	7,475,678	71,507,378
Nansemond	568,383,766	379,892,814	111,069,654	77,421,298
Surry	57,978,543	51,722,017	1,510,976	4,745,550
VIP	321,652,962	146,378,081	80,501,597	94,773,284
Williamsburg	104,425,475	11,484,126	3,280,258	89,661,091
York River	115,439,557	75,595,808	7,406,499	32,437,250
General	1,702,778,028	633,025,720	691,034,596	378,717,712
Total	\$ 4,482,685,872	\$ 2,320,480,301	\$ 1,118,424,488	\$ 1,043,781,083

D. Summary of Debt Activity

HRSD- Debt Analysis

December 31, 2025

(in thousands)

	Fixed Rate	Variable Rate	Line of Credit	Total
Beginning Balance 7/1/25	\$ 1,757,250	\$ 50,000	\$ 92,462	\$ 1,899,712
Add:				
Principal Draws	282,956	-	-	282,956
Capitalized Interest	4,606	-	-	4,606
Less:				
Principal Payments	(35,073)	-	-	(35,073)
Ending Balance 12/31/25	\$ 2,009,739	\$ 50,000	\$ 92,462	\$ 2,152,201
FY26 YTD Interest Payments	\$ (18,537)	\$ (615)	\$ (1,722)	\$ (20,874)

HRSD- Series 2016 Variable Rate Bond Analysis

January 02, 2026

	SIFMA Index	HRSD Series 2016VR	Deviation to SIFMA
Maximum	4.71%	4.95%	0.24%
Average	1.57%	1.07%	-0.50%
Minimum	0.01%	0.01%	0.00%
As of 01/02/26	2.36%	2.25%	-0.11%

Since October 20, 2011 HRSD has averaged 107 basis points on Variable Rate Debt

Subsidised Debt Activity

Source	Funder	Loan Amount	Current Drawn Total	% Remain	Initial Draw Date - Projected
WIFIA Tranche 3	EPA	\$ 346,069,223	\$ -	100%	July 2026

E. Cash and Investment Summary

Operating Liquidity Accounts	Beginning Market Value July 1, 2025	YTD Contributions	YTD Withdrawals	YTD Income Earned	Ending Market Value Dec 31, 2025	Allocation of funds	Current Mo Avg Yield
BOA Corp Disbursement Account	\$ 43,574,043	\$ 805,459,672	\$ 814,869,724	\$ 211,250	\$ 34,375,241	5.9%	0.61%
BOA Operating Accounts	14,339,684	595,576,468	598,292,455	119,499	11,743,196	2.0%	1.02%
BNY Mellon Account	7,892,401	43,750,957	39,052,160	36,689	12,627,887	2.2%	0.29%
SNAP Accounts	143,929,872	228,294,383	240,982,335	960,060	132,201,980	22.6%	0.73%
VIP Stable NAV Liquidity Pool	324,275,659	295,096,072	234,000,000	8,210,793	393,582,524	67.3%	3.93%
Operating Liquidity Accounts	\$ 534,011,659	\$ 1,968,177,552	\$ 1,927,196,674	\$ 9,538,291	\$ 584,530,828	100.0%	

VIP Stable NAV Liquidity Pool performed 0.02% above to the Va Local Government Investment Pool's (the market benchmark) in the month of December 2025.

Total Return Account	Beginning Market Value July 1, 2025	YTD Contributions	YTD Withdrawals	YTD Income Earned & Realized G/L	Ending Market Value Dec 31, 2025	Allocation of funds	Yield to Maturity at Market
VIP 1-3 Year High Quality Bond Fund	69,597,188	-	7,018	1,388,884	71,153,613	71,529,601	3.52%
Total Return Account	\$ 69,597,188	\$ -	\$ 7,018	\$ 1,388,884	\$ 71,153,613	\$ 71,529,601	

VIP 1-3 Year High Quality Bond Fund performed equal to the ICE BofA ML 1-3 yr AAA-AA Corp/Gov Index (the market benchmark) in December 2025.

	Total	Fund Alloc
Operating Liquidity Accounts	\$ 584,530,828	89.1%
Total Return Account	\$ 71,153,613	10.9%
TOTAL	\$ 655,684,441	100.0%

F. Financial Performance Metrics Adjusted Days Cash on Hand

HRSD - UNRESTRICTED CASH

December 31, 2025

Can be used for any purpose since it is not earmarked for a specific use.

	Days Cash on Hand	Adjusted Days Cash on Hand
Total Unrestricted Cash	\$ 486,223,018	676
Risk Management Reserve	(4,799,555)	(7)
Capital (PAYGO only)	(234,219,458)	(325)
Adjusted Days Cash on Hand	\$ 247,204,005	344

Risk Management Reserve as a % of Projected Claims Cost is 25% YTD compared to 25% Policy Minimum

Adjusted Days Cash on Hand Policy Minimum is 270-365 days.

G. Summary of Grant Applications, Awards and Activity

Active Capital Grants								
Grant Name	Funder	Project	CIP#	Application Submitted	Amount Requested	HRSD Award Amount	Reimbursement Rcvd	11/30/25
Community Flood Preparedness Fund	VDCR	Dozier's Corner Pump Station Replacement	AT015400	12/4/2024	\$ 6,265,669	\$ 6,265,669	\$ -	-
Community Flood Preparedness Fund	VDCR	Onancock Treatment Plant Administrative Building Design	ES010300	10/30/2024	\$ 374,400	\$ 374,400	\$ -	-
Water Quality Improvement Fund	VDEQ	Boat Harbor Pump Station and Conveyance	BH015700 BH015710 BH015720 BH015730	3/4/2024	\$ 311,286,392	\$ 294,300,592	\$ 67,000,000	-
					\$ 317,926,461	\$ 300,940,661	\$ 67,000,000	

Active Non-Capital Grants								
Grant Name	Funder	Project	CIP#	Application Submitted	Amount Requested	HRSD Award Amount	Reimbursement Rcvd	11/30/25
Non-Point Source Funding	VDEQ	Gloucester Septic to Sewer (Pay for Performance)	n/a	2/3/2024	\$ 1,180,000	\$ 1,180,000	\$ -	-
					\$ 1,180,000	\$ 1,180,000	\$ -	

H. Customer Care Center - Key Statistics

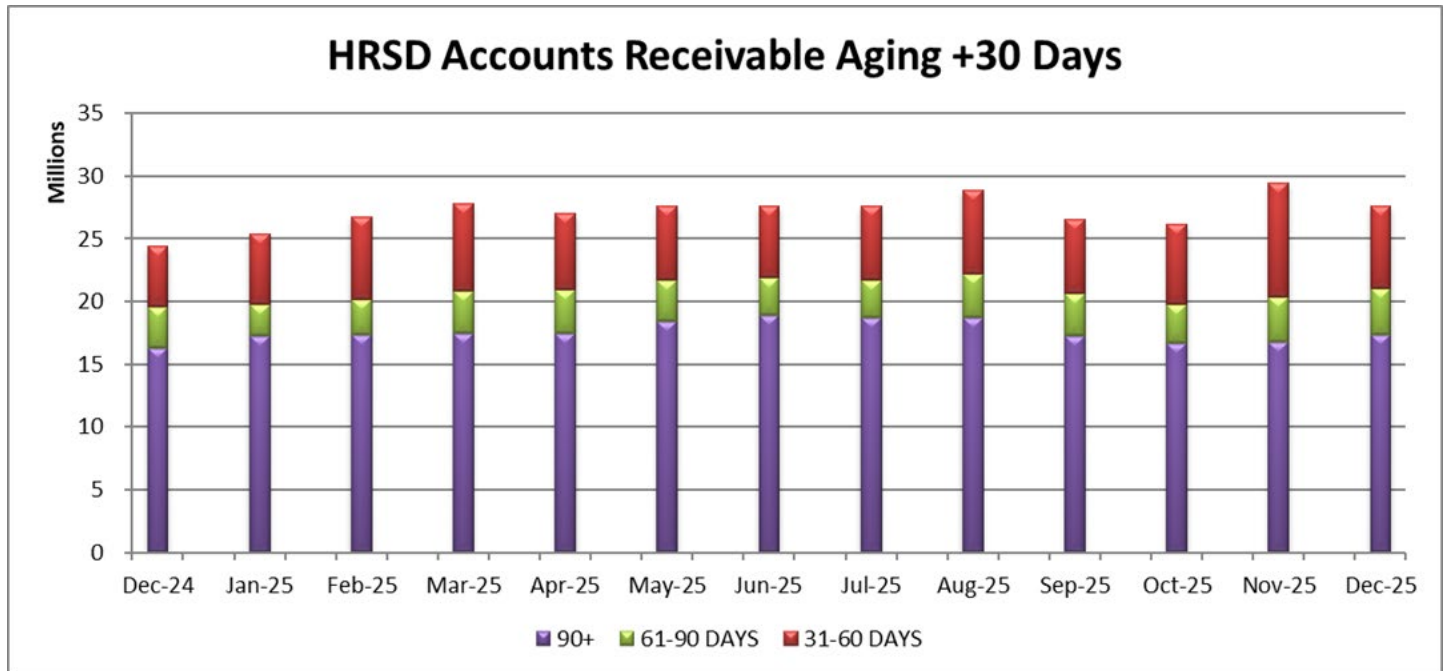
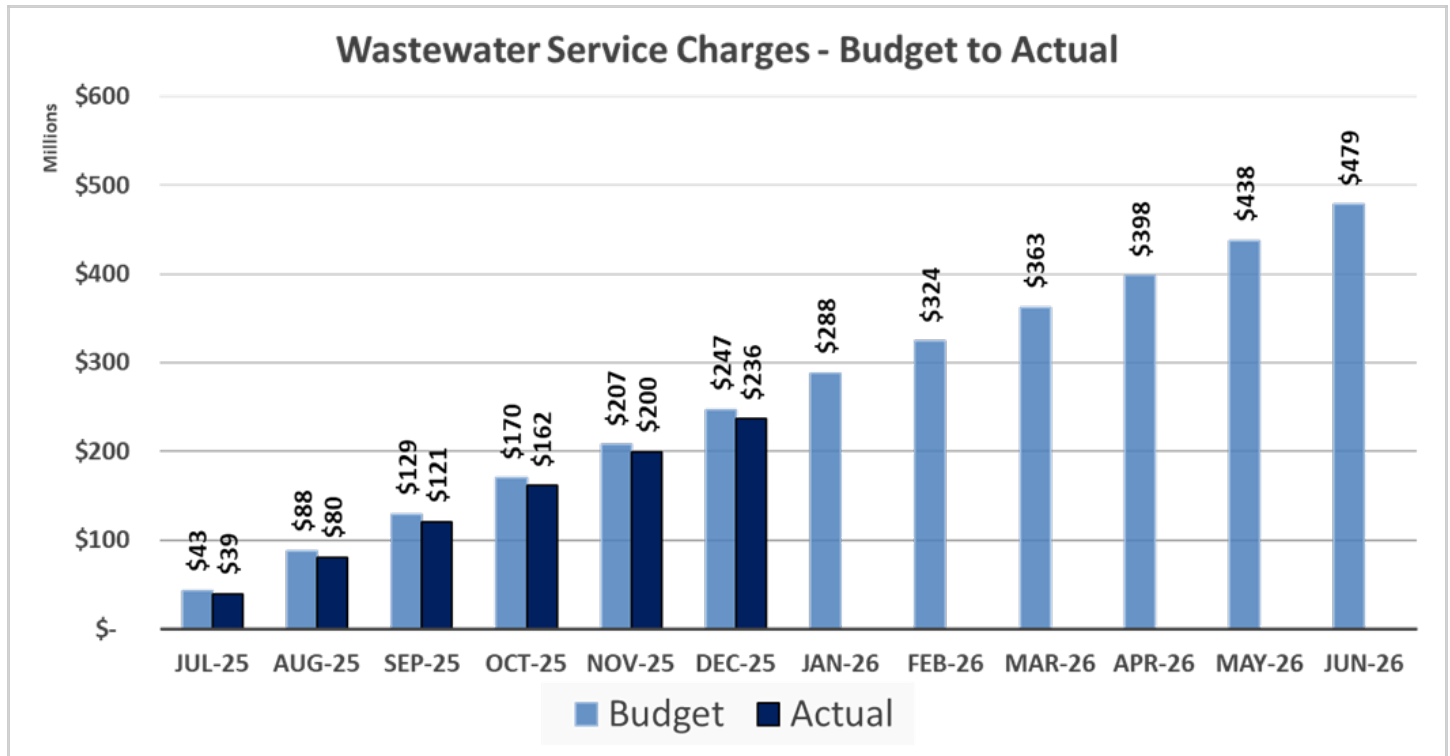

Delinquent & Late Payment Fees

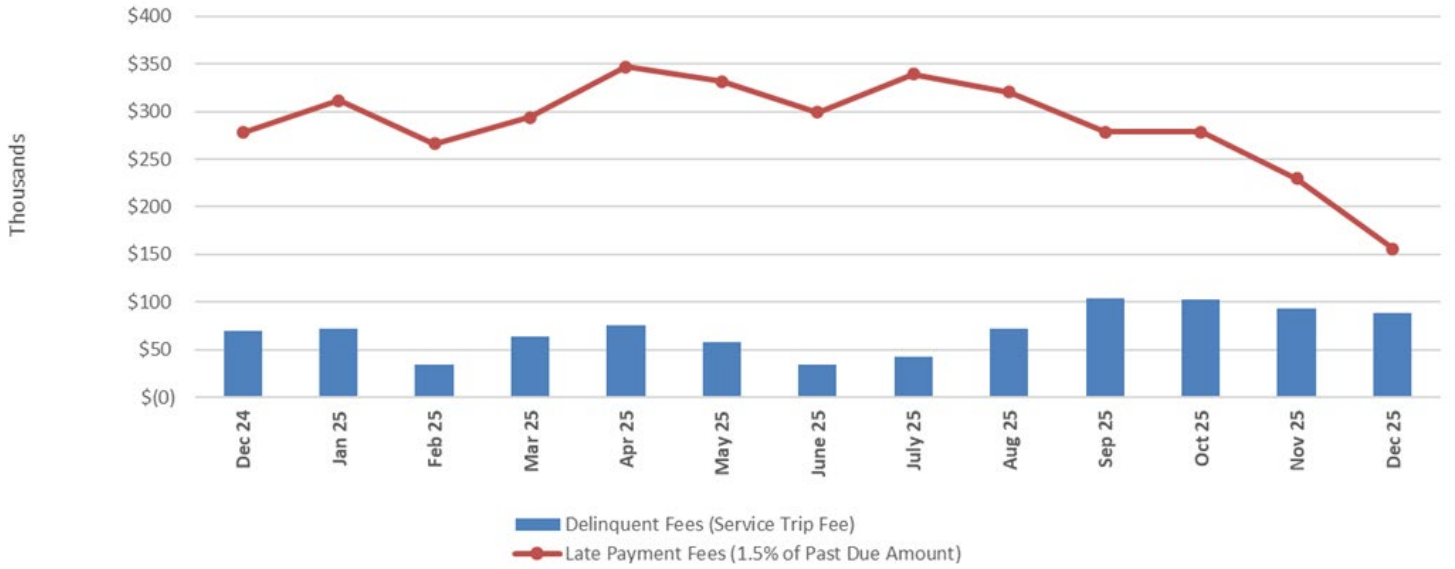

Billing Summary

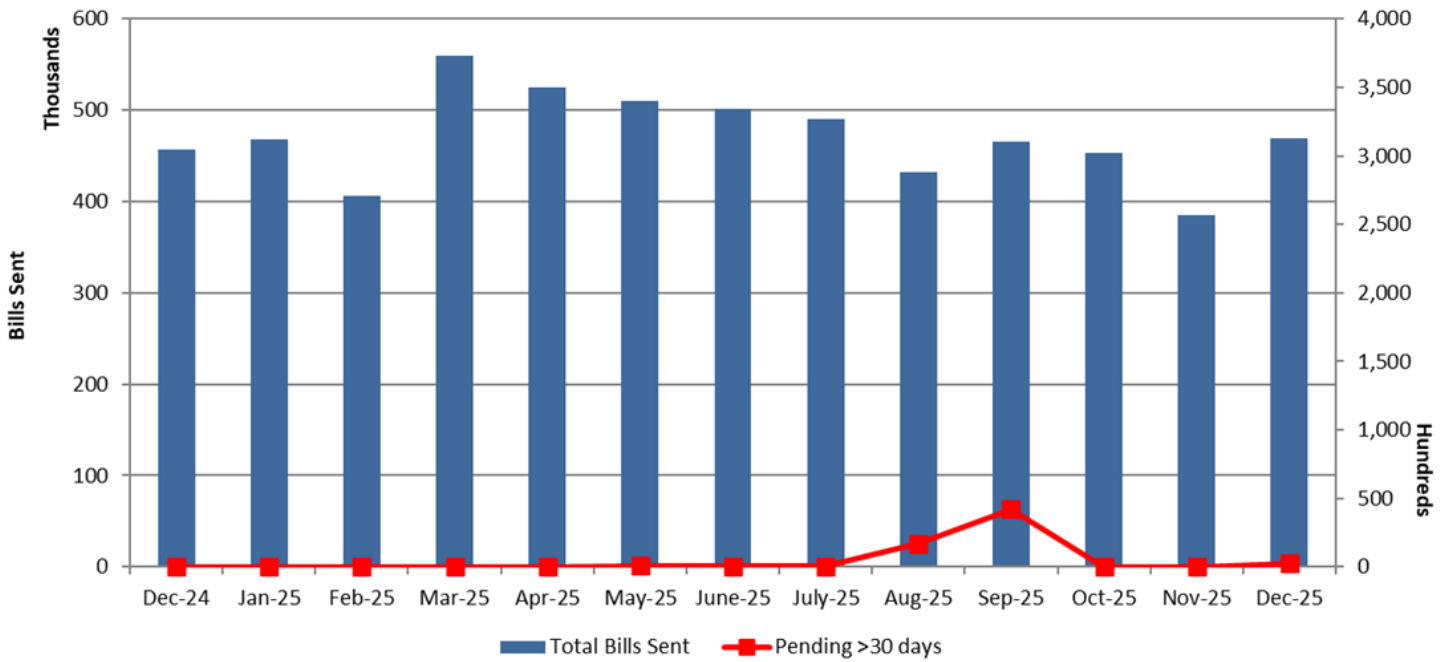

Call Center Interactions (per day)

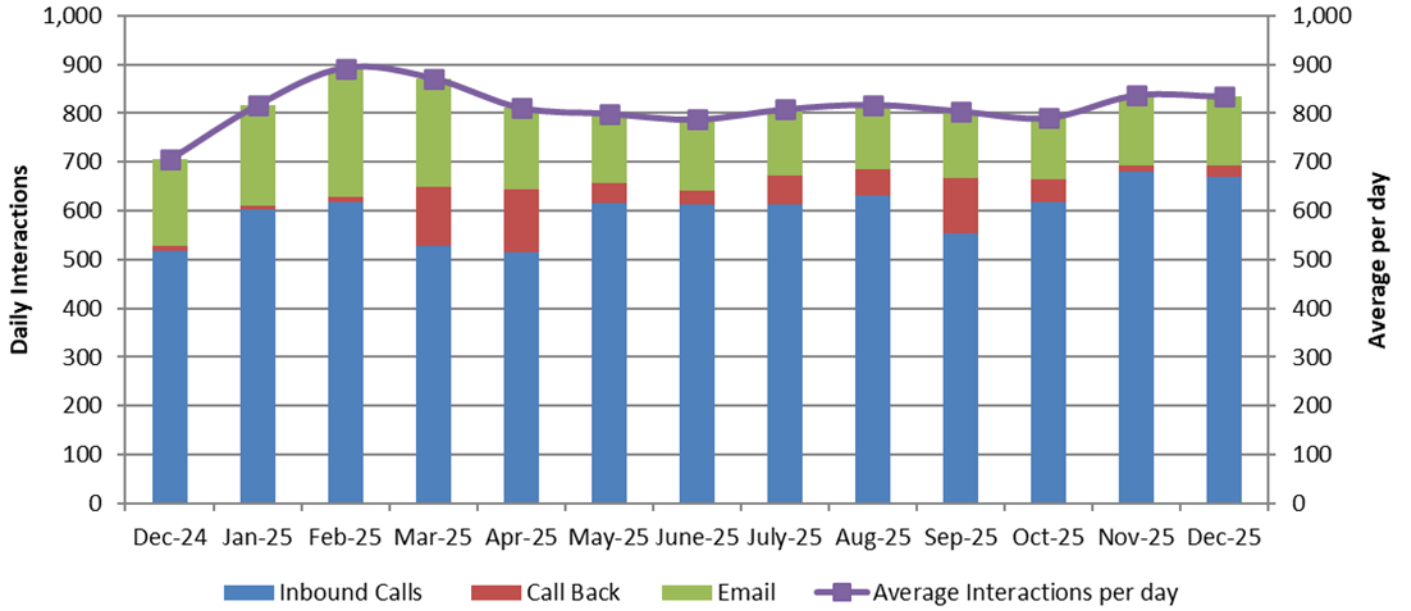

Customer Interaction Statistics

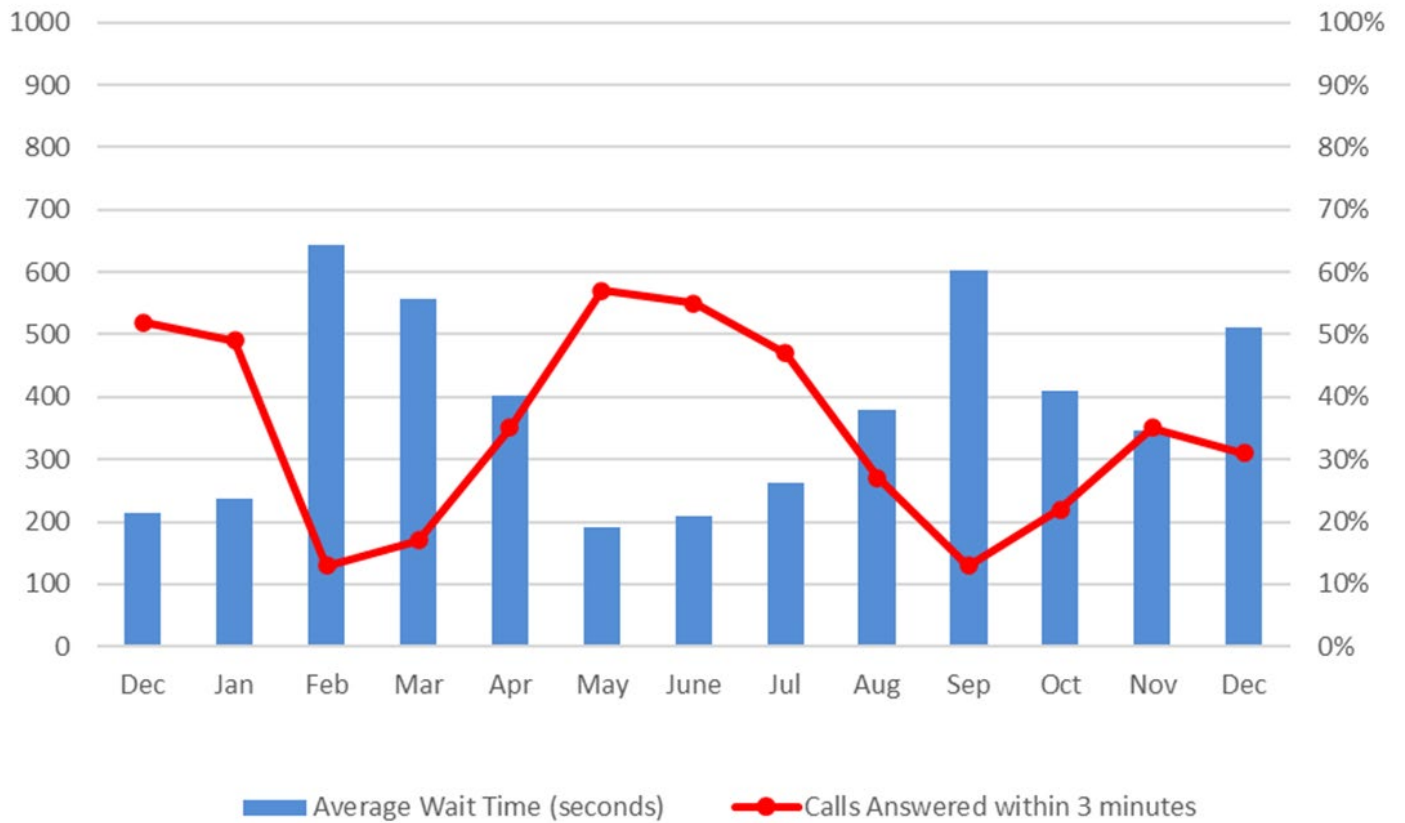

Customer Interaction Statistics	Dec	Jan	Feb	Mar	Apr	May	June	Jul	Aug	Sep	Oct	Nov	Dec
Calls Answered within 3 minutes	52%	49%	13%	17%	35%	57%	55%	47%	27%	13%	22%	35%	31%
Average Wait Time (seconds)	214	237	643	556	403	190	208	262	379	604	409	346	512
Calls Abandoned	19%	21%	45%	44%	30%	16%	19%	22%	28%	42%	33%	25%	32%

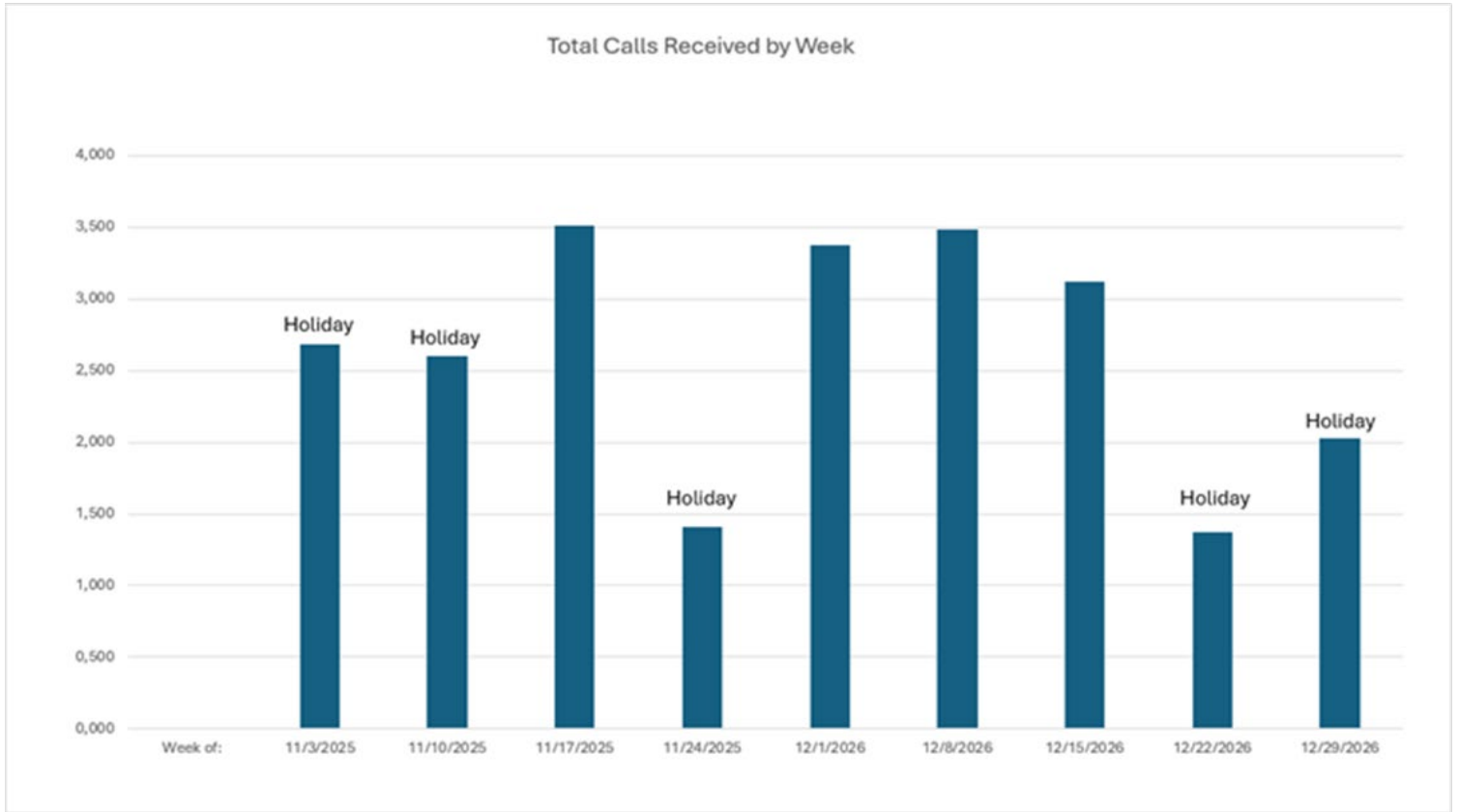

Item #	Strategic Planning Measure	Unit	December 2025
	Accounts Receivable (HRSD)	Dollars	\$54,260,891
	Aging Accounts Receivable	Percentage of receivables greater than 90 days	32.3%

I. Procurement Statistics

Savings	Current Period	FYTD
Competitive Savings	\$85,923	\$3,337,876
Negotiated Savings	\$140	\$14,900
Salvage Revenues	\$3,290	\$27,680
Corporate VISA Card - Estimated Rebate	\$21,178	\$144,813

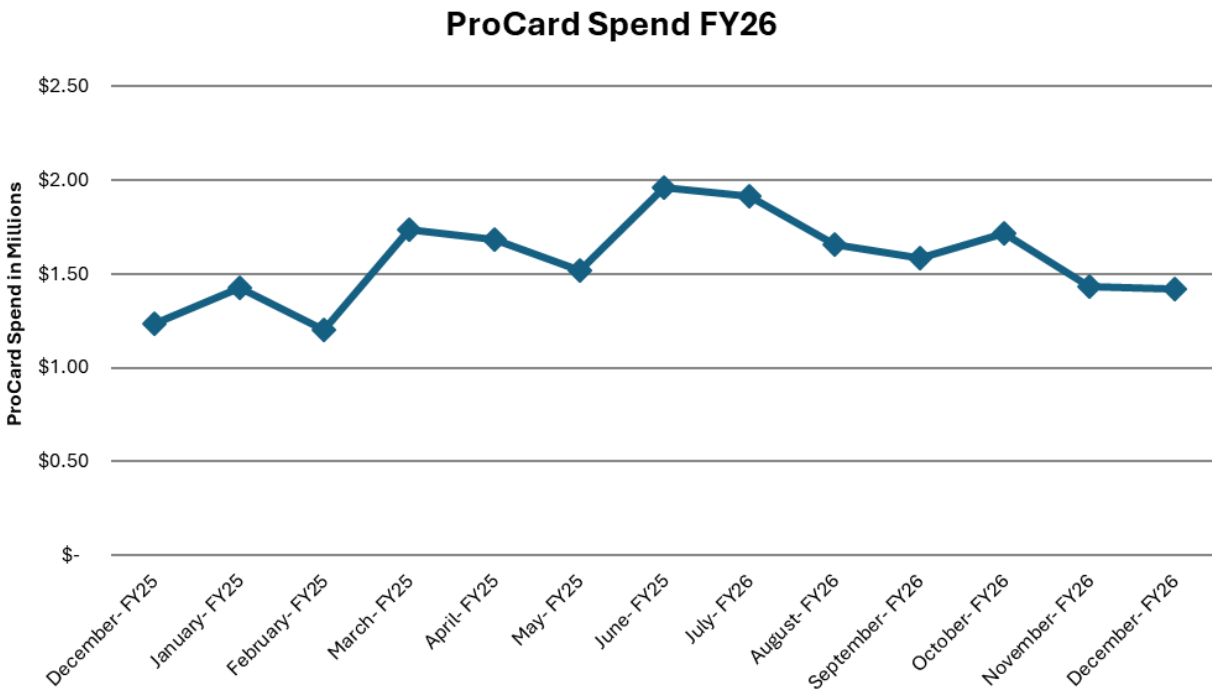

Respectfully,

Steven G. de Mik

Steven G. de Mik
Deputy General Manager/Chief Financial Officer

TO: General Manager/ Chief Executive Officer
FROM: Chief Information Officer
SUBJECT: Information Technology Division (ITD) Report for December 2025
DATE: January 8, 2026



Innovation

The IT Help Desk processed 410 work orders and requests for assistance in December.

IT staff are currently working on 72 active projects, with 40 projects on the intake cue.

Staff worked closely with the Data Analysis staff and the vendor to successfully upgrade the Aveva Pi software system.

Worked continued with the Cisco equipment refreshes, Firewall replacements and retiring of old network hardware infrastructure. This is a lengthy project due to the large amount of equipment requiring replacement and upgrades.

IT Operations staff continue working on fiber runs at the former Chesapeake-Elizabeth treatment plant and moving of technology equipment in preparation of the demolition of several structures at the plant site.

Cybersecurity staff and Senior System Engineers continue their work efforts to enhance security on operational technology systems.

ServiceNow project implementation moved into the system configuration phase in early December.

IT staff continue engagements in workshops related to Data Governance and Data Loss Prevention (DLP) with Microsoft 365 Purview configurations.

Programming staff along with Customer Care staff made significant progress in December with the data stabilization efforts for file processing of the City of Portsmouth's new billing system data files.



Talent

Mr. Brian Yu was selected for the Senior Programmer Analyst position. He will begin the new position in January 2026.

Mrs. Amy Wood was promoted from Senior Systems Engineer to Senior Systems Engineer Manager and began her new role in late December.

Recruitment efforts will begin in January 2026 for the Operational Technology Security Manager, IT Senior Project Manager, Senior Systems Engineer and Oracle Developer.

Respectfully,

Mary Corby

Chief Information Officer

TO: General Manager/Chief Executive Officer
FROM: Chief Operating Officer
SUBJECT: Operations Monthly Report for December 2025
DATE: January 13, 2026



Community Engagement

Staff participated in several community events as follows:

1. On December 18, Mr. Patrick Porto, Inspector with South Shore (SS) Interceptor Operations, gave two presentations on career opportunities pertaining to plant maintenance to the Virginia Beach Technical and Career Education Center. Mr. Porto also facilitated a competition among students to build a closed loop PVC system to simulate likely work for plant maintenance.
2. Small Communities Department (SCD) along with HRSD Planning and Analysis met with the Operations Superintendent for New Kent County for a tour of the Parhams Landing Treatment Plant and to discuss possible partnership opportunities for future projects.
3. SCD staff met with Accomack County staff to inspect the Chesapeake Square Pump Station that will be turning over to HRSD in the next few months once property issues have been worked out.



Environmental Responsibility

Treatment and Interceptor System Reportable Items:

There were multiple events reported this month. Additional details are available in the Air and Effluent Summary in the Water Quality monthly report.

Internal Air and Odor Compliance:

There were multiple events reported this month. Additional details are available in the Air and Effluent Summary in the Water Quality monthly report.

1. The James River Treatment Plant had four odor scrubber exhaust exceptions for scrubber hydrogen sulfide (H₂S) levels above two parts per million. All were due to higher than anticipated H₂S for chemical being fed.
2. The Williamsburg Treatment Plant (WBTP) had two odor scrubber exhaust exceptions for scrubber H₂S levels above 8 parts per million due to higher-than-normal odor scrubber influent H₂S levels. Chemical feed to the scrubber was increased to lower effluent H₂S levels.
3. There were two reportable events for the odor control system at the Boat Harbor Plant (BHTP). The caustic lines feeding the scrubber system froze on December 15. Without the addition of

caustic, the odor control system could not remove enough sulfide to remain under five ppm. The second event was due to caustic addition being added to the second stage tower instead of the first stage when using the system in single tower mode for wintertime function. Adding the caustic to the first stage solved the issue.

4. Boat Harbor Treatment Plant staff, along with TSD, successfully completed the MACT 129 testing on Incinerator #1. Results of the MACT 129 test are still pending, but preliminary results indicate a successful test. This will be the last stack test required for the BHTP before plant closure in April 2026.
5. Army Base Treatment Plant had one hydrogen sulfide exception where concentration exceeded five ppm on OCS A while repairs were being performed on the associated caustic line.
6. Virginia Initiative Plant (VIP) experienced one exception for no THC readings in one hour. The system failed auto calibration and was corrected with a manual calibration.

Additional Topics of Interest:

1. The Nansemond Treatment Plant (NTP) continues to face challenges with the startup of the ANRI project. The #2 rectangular primary clarifier completely failed with only NPW in the tank, and the contractor-selected chain appears to be the cause. The vendor is scheduled to be onsite in January to assess the issue. In addition, staff and contractors are still working through multiple issues with Aeration Tank #6 (AT6), the first PdNA tank at NTP, as they attempt to bring it online. AT6 is needed as soon as possible with colder temperatures approaching and new nitrogen limits in effect. Modifications to AT6 are expected to be completed during the first week of 2026, with the tank placed into service immediately afterward.
2. Atlantic Treatment Plant (ATP) staff successfully completed the annual THP turnaround. All pressure vessels and lines were cleaned and inspected, all PRVs were replaced, and the feed and blowdown valves were fully rebuilt. Staff also replaced a section of the flash steam line that had been repaired twice previously. The THP system was only down for 37 hours, and staff were able to retain all solids in the tanks, eliminating the need for raw solids hauling.
3. The total volume of Sustainable Water Initiative for Tomorrow (SWIFT) recharge into the Potomac aquifer for the month of December was 3.0 million gallons (MG) (10.5 % Recharge Time based on 650gpm). The main cause for the low recharge rate is related to a higher (1.0 mg/L) nitrite, which causes issue with the ozone demand in the SWIFT process. The higher nitrite is related to the need to get Aeration Tank #6 in service for the additional aeration capacity on the NTP side of the process.
4. SS Electrical and Instrumentation (E&I) staff completed the heat-tracing project at the Onancock Treatment Plant (OTP). This project ensures that all chemical feed lines and other critical process equipment are protected from freezing, thereby reducing the risk of process interruptions.
5. SS E&I staff collaborated with Megan Bachman, Treatment Plant Engineer (TPE), to troubleshoot the Greasezilla decant tank level measurement devices at the NTP. Following successful configuration changes to Decant Tank #2, the same settings were applied to Decant Tanks #3 and #4. Since implementation, level indications within the Distributed Control System (DCS) have remained accurate, stable, and reliable, with no further instances of signal dropout.

6. King William Treatment Plant flows continues to increase with new connections into the collection system every month. The plant membranes were replaced eight months ago, and the new membranes are becoming fouled. Pump and haul efforts are having to be scheduled every other day to keep up with influent flow. New membranes were ordered in December and expected delivery is in February. The Kubota Membrane CIP continues to be delayed, and the expected arrival date of the new membrane system is currently early summer.
7. SCD staff on the Eastern Shore continue to work with TSD on resolving the Nassawadox Rehab Facility grease and debris issues that have been causing backups in the downstream collection system. Technical Services Division (TSD) issued a Notice of Violation to the Rehab facility.
8. Material Transportation & Logistics (MTL) staff have hauled 40 loads of Ash for a total of 341.03 dry tons. Staff have hauled 116 loads of Primary Clarifier Solids (PCS), in addition to 67 loads of Thickened Waste Activated Biosolids (TWAB) for a total of 4281.69 (3/4 month of data) wet tons. Staff have also hauled 87 loads from ATP to McGill for the month of December, for a total weight of 1796.50 wet tons.
9. North Shore (NS) Interceptor Operations progress continues on the odor control and flow augmentation changes for Lodge Road Pump Station. These are in-house HRSD projects to be constructed by NS Operations staff.



Financial Stewardship

1. On December 16, SS Interceptor Operations partnered with NTP staff to clean the Regional Residuals Facility (RRF) removing approximately five cubic yards of material from the grit traps and bar screen trough to maintain peak operating efficiency. By working together and utilizing internal resources, this effort resulted in daily cost savings of approximately \$5,000.
2. On December 18, SS Interceptor Operations received a call that the VIP experienced a water main failure. SS Interceptor Operations staff mobilized with equipment, excavated, identified and repaired the failed watermain. By working together and utilizing internal resources, cost savings for the district are estimated to be thousands of dollars.
3. SCD staff transported the Westpoint Dewatering Trailer to Onancock Treatment Plant and Eastern Shore SCD staff were able to dewater the accumulated solids from both digesters. The dewatering trailer experienced a polymer feed issue which led to a sludge spill on plant site that was promptly cleaned up. Staff is looking into a more encompassing containment system, and a float has been added to the screw press to shut down the trailer if polymer feed is disrupted and a spill occurs.



Innovation

1. HRSD will be conducting a pilot test of a granular activated carbon (GAC) reactivation process that uses superheated steam. The pilot will be conducted at the SWIFT Research Center using GAC previously exhausted in the full-scale contactors. This technology was developed in South Korea and is being marketed in the US by Wintec Glovis. This is one of two innovative GAC reactivation technologies, the other being industrial microwave, that are being considered

and evaluated compared to the standard thermal reactivation approaches that include multiple heath and rotary kiln furnaces.

2. VIP and E&I staff are assisting TSD with a shellfish study which will be hosted at VIP. Staff completed the conduit and piping runs this month which will allow for a pump to feed water from the Elizabeth River to the pilot location in the RAS/WAS building.
3. SCD is moving forward with automated ammonia-based aeration control for the Urbanna Treatment Plant.



Talent

1. At WBTP plant operator Ms. Marrison Metcalf obtained a Class 2 Virginia Wastewater Works License and plant operator Mr. Kris Valcourt a Class 3 License.
2. As part of the initial Option One Boat Harbor Closure contracts, three employees retired from the ATP: Mr. Jeff Powell, Mr. Eddie Suthers, and Mr. Joel Niemi. In addition, Mr. Stan Brzozowski retired from SCD, and Mr. Jerry Mitchell retired from the BHTP.
3. Mr. Andy Nelson retired as the SWIFT and ANRI Ops Project Manager. We wish everyone a happy retirement!
4. SS Interceptor Operations welcomed Mr. Henry Pierce, Maintenance Operator, on December 8 and Mr. Chris Blanchard, Maintenance Technician, on December 22.
5. SS Interceptor Operations had two lateral position changes in December. Mr. Matthew Tribble moved from Lead Maintenance Supervisor to Lead System Supervisor on December 6 and Mr. Michael Twark moved from Maintenance Assistant to Utility Locator on December 20.
6. Mr. Bob Kincaid officially retired from VIP after 47 years of service. He had been mentoring Cole Tomlinson over the past several months, and Cole will now step into Bob's role as VIP Superintendent.

Respectfully submitted,

Sam McAdoo
Acting Chief Operating Officer

[Attachment: MOM Reporting](#)

MOM Reporting Numbers

MOM #	Measure Name	Measure Target	July	Aug	Sep	Oct	Nov	Dec	Jan	Feb	Mar	Apr	May	June
2.7	# of PS Annual PMs Performed (NS)	37	3	2	3	4	1	4						
2.7	# of PS Annual PMs Performed (SS)	53	3	3	3	1	2	4						
2.7	# of Backup Generator PMs Performed	4.6	11	14	14	24	7	4						
2.8	# of FM Air Release Valve PMs Performed (NS)	234	307	401	318	362	217	237						
2.8	# of FM Air Release Valve PMs Performed (SS)	1,550	232	58	147	90	39	134						
2.9	# of Linear Feet of Gravity Clean (NS)	2,417	4,434	3,606	3013	2246	5828	5,517						
2.9	# of Linear Feet of Gravity Clean (SS)	2,417	1,070	1112	1774	171	1400	1,773						

TO: General Manager

FROM: Chief People Officer

SUBJECT: Talent Management Monthly Report for December

DATE: January 13th, 2026



Talent

In December 2025, HRSD made progress in staffing, employee development, and safety. **Human Resources** launched 11 recruitment campaigns, filled 18 positions, updated policies, and prepared the Awardco recognition platform for a January 2026 launch. **Learning & Development** celebrated the LAMA cohort graduation, onboarded 18 apprentices, and advanced Career Pathways with interviews, promotions, and professional development support. **Safety & Security** conducted inspections, trainings, and construction monitoring, recognized top-performing work centers, and addressed minor injuries and property incidents. Security enhanced site operations through signage, system planning, and facility assessments.

Human Resources (HR)

Talent Acquisition

- Launched **11 new recruitment campaigns**.
- Secured acceptance of **18 job offers**.

Policy Updates

- Distributed updates to the **HR Manual**, highlighting:
 - Bereavement Leave enhancements
 - Standby and Callback policy updates
- Reviewed and revised HRSD policies, focusing on:
 - Corrective action
 - Progressive discipline
 - Grievance procedures

Recognition & Awards

- Finalized setup/configuration of **Awardco platform**:
 - Supports service awards, retirement awards, peer-to-peer recognition, and supervisor-to-employee recognition
 - **Go-live scheduled for January 2026**

Wellness Program

- Participation continues to grow
 - Program offerings include:
 - Plan education
 - Wellness presentations
 - Individual & group coaching
 - Virtual guided meditation
-

Learning & Development (L&D)

Year-End Momentum

- Focused on:
 - Team connection
 - Program milestones
 - Forward-looking planning

LAMA Cohort Graduation

- Capstone event showcased “wicked problem” solutions
- **Winning team members:** William Honeycutt, Amber DiSomma, Dan Holloway, Nick Hamilton, Kyle Schellin
- Innovative ideas emphasized awareness & communication

Work Center Outreach

- NTP site visit to (re)introduce L&D resources & support services

Apprenticeship Program

- **Term 2 concluded**, 18 new apprentices onboarded
- Activities included:
 - Two ADA course updates for instructors
 - Extra course for Eastern Shore apprentices to minimize travel/work disruption
 - BHTP visit to assess future training equipment needs

Career Pathways Program

- Since May 2025:
 - 63 participants engaged
 - 101 one-on-one appointments
 - 27 interviews communicated, 10 promotions confirmed
- December highlights:
 - 4 new participants
 - 2 job shadowing events in Water Quality
 - 6 applications tracked to interview stage
 - 2 employee promotions celebrated
- Ongoing interests:
 - 22 exploring continuing education
 - 24 seeking career mapping support

- 33 requesting résumé review/interview prep
-

Safety & Security

Safety Inspections & Training

Activity	Metric
Unscheduled safety inspections	7
Safety training sessions	8
Construction walks for site monitoring	8
Contractor briefings	2

Safety Recognition

- Quarterly Safety Inspection Awards:
 - **Small Work Center Winner:** Facility Support
 - **Large Work Center Winner:** Army Base
 - **Most Improved:** Middle Peninsula

Security Operations

- Delivered private property signage to **North Shore Operations**
- Continued coordination with Motorola for **ALTA Visitor system pilot** at Main Office lobby
- Onsite visits to **King William Plant & West Point Plant** for gate assessment & price quotes

Incidents

December Incident Summary		
Event	December	Previous Month
Auto accident/property damage incident	5	3
Work-related injuries requiring medical attention	4	0
Accident resulting in lost time	0	0

Respectfully submitted,

Christina Gibson

Chief People Officer

TO: General Manager/ Chief Executive Officer
FROM: Chief of Water Quality (CWQ)
SUBJECT: Monthly Report for December 2025
DATE: January 13, 2025



Environmental Responsibility

HRSD's Regulatory Activities:

- Monthly Discharge Monitoring Report (DMR) Summary and Items of Interest: [Effluent and Air Emissions Summary](#).
- 6 Permit Exceedances out of 27,933 Total Possible Exceedances to date in FY2026.
- 86.3 million pounds of pollutants removed to date in FY2026.

Pretreatment and Pollution Prevention (P3) Program Highlights:

- One civil penalty in the amount of \$2,750 was issued in December to United Site Services of Maryland dba Russel Reid – Barhamsville, a portable waste hauler. The civil penalty was paid in full.

An Enforcement Order was issued in November 2025 for administrative violations: multiple late reports throughout the year resulting in three violations, escalating for repeated occurrences. Failure to make timely response resulted in a separate administrative violation.

At the Permittee's request, the HRSD Indirect Wastewater Discharge Permit was discontinued as it was no longer needed.

Environmental and Regulatory Advocacy

Chief participated in the following advocacy and external activities:

- Rappahannock River Basin Commission meeting: With Technical Services Department (TSD) Environmental Scientist, Dr. Chris Burbage, provided a briefing on the status of Virginia's biosolids research related to the fate and transport of per- and polyfluoralkyl substances (PFAS).
- Annual meeting of the Virginia Biosolids Council: Highlights of the meeting included discussion around best practices for implementing a PFAS monitoring program in biosolids.
- Virginia Association of Municipal Wastewater Agencies (VAMWA) annual board meeting: Highlights of the meeting included a discussion of Governor Spanberger's transition and environmental policy statement as well as planning for the upcoming legislative session.

- VAMWA quarterly membership meeting: received updates from Department of Environmental Quality staff on various regulatory activities:
 - The nutrient general permit will be reissued this year. Registration statements due November 1, 2026.
 - Periodic review of the reuse regulation is scheduled for 2026. This is expected to trigger an update of the regulation.
 - The annual DEQ water quality monitoring plan will be released in early 2026.
- Virginia Forever Board Meeting: Discussed the upcoming legislative session and highlights from Governor Youngkin's recently released biennial budget.
 - The budget included an apparent cash funded carve out for a portion of the Boat Harbor project's Water Quality Improvement Fund (WQIF) eligible reimbursement, likely intended to address a complex tax issue associated with bond funding for a political subdivision.
 - There was no other WQIF funding for wastewater projects in this budget. Additional advocacy will be needed to ensure that the needs are met as the budget goes through revision during the General Assembly session.
 - The Secretary of Natural and Historic Resources and the Secretary of Agriculture and Forestry provided a briefing on the budget's highlights.
 - Chief of WQ was elected Secretary/Treasurer for a 2-year term.
- University of Colorado (CU) Boulder Water Reuse Advisory Board: discussed challenges and opportunities for CU's stand-alone Water Reuse Academy, the Water Reuse Program track in the research-based Master of Science and PhD programs, and the Professional Master's Program.
- The Potomac Aquifer Recharge Oversight Committee (PAROC) for updates on Potomac Aquifer Recharge Monitoring Laboratory (PARML) and HRSD SWIFT activities.



Financial Stewardship

- HRSD's Municipal Assistance Program (MAP)
 - Provided sampling and analytical services on a cost-reimbursement basis to the following:
 - Harrisonburg – Rockingham Regional Sewer Authority (HRRSA)
 - Northumberland County
 - Rivanna Water and Sewer Authority
 - Westmoreland County

- [MAP Billed Reimbursements](#) for service provided from October 1 to December 31, 2025.
- [MAP Invoice Summary](#) for the fourth Quarter 2025 calendar year.



Talent

- Paul Walters, P3 Technician, retired after 36 years of service to HRSD and our communities.
- Haley Sorensen and Regan Allen were hired as P3 Technicians. Welcome to HRSD!



Community Engagement

- Microbial Source Tracking (MST) partnering localities and projects.
 - City of Chesapeake (Southern Branch)
 - City of Hampton (southeast)
 - City of Newport News (Hilton Beach)
 - City of Suffolk (downtown)
 - City of Virginia Beach (Thalia Creek)
 - James City County



Innovation

- Chris Burbage, Kenny Hoffman, and April Richardson were co-authors of “[PFAS retention and distribution in the vadose zone of three soil types impacted by biosolids application](#)”, published in the Journal of Environmental Management. This paper documents the PFAS research at the HRSD Progress Farm in collaboration with Linda Lee and Lynda Peter of Purdue University.
- The building permit for the new Central Environmental Laboratory building was issued by the City of Virginia Beach, paving the way for full construction to begin on the laboratory expansion, designed to meet HRSD’s growing analytical needs for 20 years.

Respectfully submitted,

Jamie Heisig-Mitchell
Chief of Water Quality

Municipal Assistance Billed Reimbursements per Service From 10/01/2025 to 12/31/2025

Attachment 1

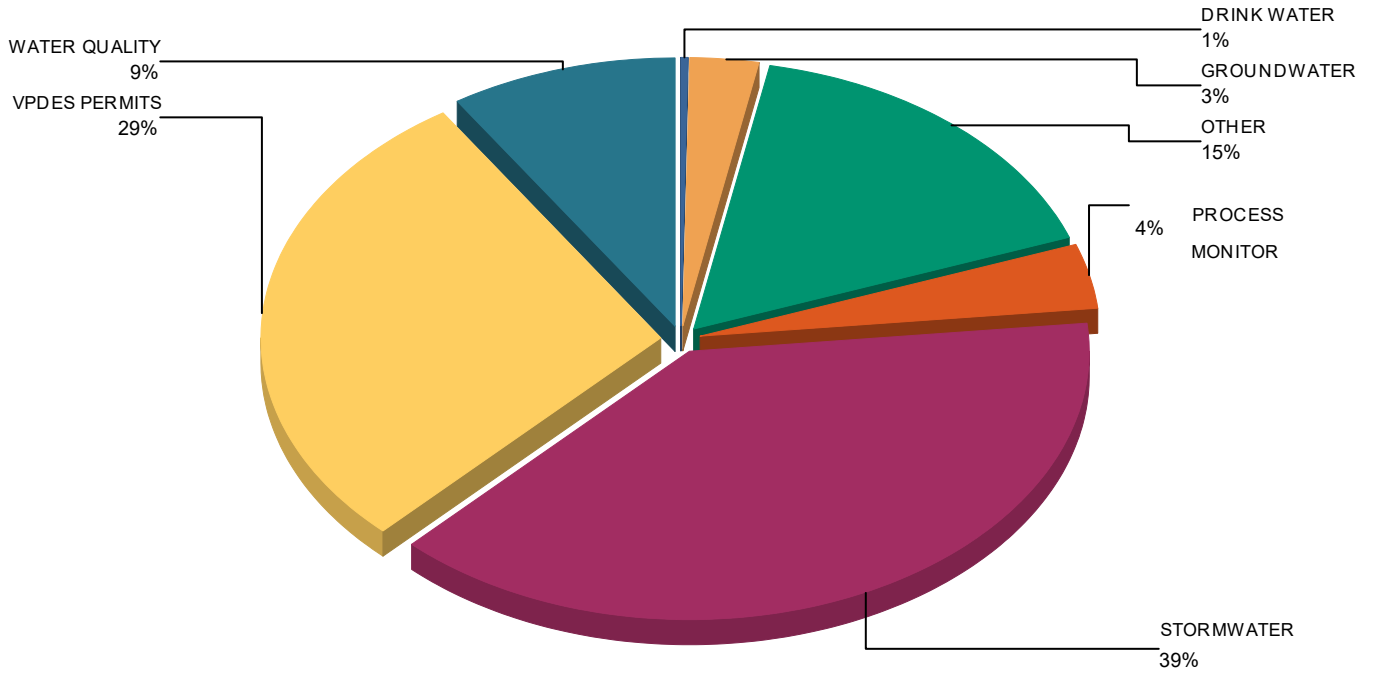

Notes: Other = Equipment purchase, consultation, validation studies, boater pump-out program, etc.

Municipal Assistance Invoice

From 10/01/2025 - 12/31/2025

Municipality	Reimbursements
Accomack County	\$4,581.30
Buckingham County	\$258.88
CITY OF CHESAPEAKE UTILITIES	\$1,134.78
City of Emporia	\$303.45
City of Franklin	\$4,151.08
City of Hampton	\$4,914.73
City of Norfolk	\$3,970.65
City of Norfolk-Dept of Utilities	\$2,386.22
City of Portsmouth	\$6,871.89
City of Roanoke	\$525.00
City of Suffolk	\$2,936.04
City of Virginia Beach	\$8,481.08
HRPDC	\$64,250.00
Henrico County	\$1,531.88
Hopewell RWTF	\$6,108.01
Lynnhaven River NOW	\$254.54
New Kent County	\$10,918.09
Northampton County WWTP	\$1,991.38
Northumberland County - Callao WWTP	\$2,631.91
PWSCA - VAW	\$8,453.48
Spotsylvania County FMC	\$1,471.41
St Brides Corr Ctr WWTP	\$2,801.67
Town of Cape Charles-VAW	\$8,181.95
Upper Occoquan Service Authority	\$13,114.06
Virginia Aquarium & Marine Science Ctr	\$1,622.70
Virginia Department of Health	\$6,530.54
Westmoreland County	\$1,342.20
Totals:	<u>\$171,718.92</u>

EFFLUENT SUMMARY FOR DECEMBER 2025

PLANT	FLOW mgd	% of Design	BOD mg/l	TSS mg/l	FC #/UBI	ENTERO #/UBI	TP mg/l	TP CY Avg	TN mg/l	TN CY Avg	CONTACT TANK EX
ARMY BASE	9.37	52%	4	3.1	1	1	0.22	0.33	3.4	4.7	26
ATLANTIC	43.89	81%	12	16	3	5	NA	NA	NA	NA	5
BOAT HARBOR	11.24	45%	6	5.8	2	2	0.26	0.63	14	19	1
CENT. MIDDLESEX	0.017	70%	<2	<1.0	<1	<1	NA	NA	NA	NA	NA
JAMES RIVER	11.13	56%	8	8.9	6	7	0.86	0.72	9.2	7.4	27
KING WILLIAM	0.092	92%	0	0.10	NA	1	0.086	0.13	2.0	2.9	NA
NANSEMOND	16.43	55%	8	5.8	10	8	0.42	1.4	5.4	5.1	3
ONANCOCK	0.253	34%	<2	<2	<1	2	0.79	0.27	2.8	2.8	NA
CHINCOTEAGUE (SB)	0.009	23%	<2	4.3	3	3	NA	NA	NA	NA	0
URBANNA	0.042	42%	16	15	10	18	3.4	4.7	13	18	NA
VIP	25.66	64%	4	2.9	3	2	0.35	0.55	3.4	4.5	3
WEST POINT	0.311	52%	22	23	2	2	1.8	2.2	22	16	0
WILLIAMSBURG	7.83	35%	8	8.2	2	2	0.50	0.60	3.3	3.0	24
YORK RIVER	11.81	79%	4	0.91	1	3	0.15	0.37	10	4.9	4
	<u>138.08</u>										

% of
Capacity

North Shore	51%
South Shore	67%
Small Communities	42%

AIR EMISSIONS SUMMARY FOR DECEMBER 2025

	No. of Permit Deviations below 129 SSI Rule Minimum Operating Parameters							Part 503e Limits			
	Temp 12 hr ave (F)	Venturi(s) 12 hr ave (in. WC)	PD 12 hr ave (GPM)	Precooler Flow 12 hr ave (GPM)	Venturi Flow 12 hr ave (GPM)	Tray/PBs Flow 12 hr ave (GPM)	Scrubber pH 3 hr ave	Any Bypass Stack Use	THC Mo. Ave (PPM)	THC DC (%)	BZ Temp Daily Ave Days >Max
MHI PLANT											
BOAT HARBOR	0	0	0	0	0	0	0	0	17	88	0
VIP	0	0	0	0	0	0	0	0	29	99	0
WILLIAMSBURG	4	1	0	0	0	0	0	7	30	87	0

ODOR COMPLAINTS

ARMY BASE	0
ATLANTIC	4
BOAT HARBOR	0
JAMES RIVER	0
NANSEMOND	0
VIP	0
WILLIAMIBURG	0
YORK RIVER	8
NS OPS	1
SS OPS	0
SCD	0
NON-HRSD	0

Items of Interest – December 2025

MULTIPLE HEARTH INCINERATION (MHI)

Total Hydrocarbon (THC) monthly averages (not to exceed 100 ppm) were met by all three MHI plants (Boat Harbor, Virginia Initiative, and Williamsburg). The THC continuous emissions monitoring (CEM) valid data capture was 87% or more.

The three operating MHI plants had five (5) 129 operating parameter deviations and five (5) minor uses of the emergency bypass stack (<60 minutes), and two (2) reportable uses of the MHI bypass (>60 minutes).

On 12/1/25 DEQ sent their final approval of the results from the Williamsburg Treatment Plant MHI #2 PM only stack test conducted on 9/25/25. After discussion with DEQ, MHI #2 will continue to operate using the minimum operating parameters established during their last full stack test on 01/31/2023. WBTP's MHI #2 minimum operating parameters will be reset based on the results of the upcoming 3/10/26 full 129 emission limits stack test.

On 12/9/2025 Boat Harbor Treatment Plant completed a full 129 emissions limit stack test on MHI #1. Final analytical results are pending, but field results from the testing contractor's CEMS showed good results on measured gases.

AIR PERMITS and ODOR CONTROL

There was a total of thirteen (13) odor complaints this month.

York River Treatment Plant received eight (8) odor complaints from the neighbor at 718 Back Creek Rd. In addition to responding to the individual complaints, an extensive response was sent to this neighbor on 12/29/25 explaining that no treatment or odor control upsets had occurred during the holiday period when most of her complaints were received. Her home's location is susceptible to offsite plant odors, swamp/low tide odors, and sewer odors from the York County vacuum sewer system. We conveyed our intentions to increase monitoring and resources in her area to try and determine the exact cause(s) of the odors she is experiencing.

Atlantic Treatment Plant received four (4) odor complaints. One complaint came from LagoMar at the beginning of the annual THP turnaround & inspection process. AT Ops worked to minimize odors produced by this maintenance and no other odor complaints were received during the turnaround. The other complaints came from the neighbor on Kitimal Drive. Plant staff respond to these complaints and take corrective action as needed. Digester gas pressures have been running high, which may have contributed to some of these complaints. ATP Ops are working diligently to empty condensate traps and equalize gas across the system. Communications

personnel provides responses to our neighbors as appropriate and TSD records the complaints in the air permit required odor complaint log.

The new Willard Avenue Pump Station received one (1) odor complaint from a next-door neighbor. The complaint was received by the Project Manager in the evening and TSD responded the following day. The odor control station's blower had been turned off due to the controls being switched to auto rather than hand. The settings were corrected, which started up the OCS and TSD stayed on site to monitor and confirm improvement of odor treatment and decreasing H₂S values through the system.

TREATMENT

Army Base

On December 27, water was discovered coming from under the pavement and initially assessed as potable water. Excavation of the site began on December 30, which was then discovered to be a leak of non-potable water (NPW). The NPW line was then secured to stop the leak and excavation resumed. Approximately 25,000 gallons of chlorinated NPW were released to the Elizabeth River.

Nansemond

On December 30, NPW was released after a line cracked due to freezing temperatures. Approximately 9,400 gallons of NPW were unrecoverable from the ground.

SYSTEM

On December 2, a contractor performing work on an adjacent CIP notified HRSD staff of raw wastewater pooling in the intersection of Bainbridge Boulevard and Great Bridge Boulevard. Flows were diverted, taking pressure off the line and stopped the spill. Staff mobilized a Vactor truck to clean up standing sewage and are working with the city of Chesapeake on the repair approach. Approximately 1,000 gallons of raw wastewater were not recovered from the storm drain system.

SYSTEM/TREATMENT, SMALL COMMUNITIES, AND EASTERN SHORE

Onancock

On December 10, the mobile dewatering trailer experienced a failure with the polymer feed. The screw press became overwhelmed with mixed liquor feed and spilled out the back of the trailer. The containment vessel was in position, but the line clogged due to the volume and thickness of material. Staff were able to recover 6,200 gallons with 1,956 gallons of mixed liquor unrecoverable from the ground.

Urbanna

On December 17, the UV system banks were discovered to be off during preventative maintenance being performed on the effluent flow meter. Fecal Coliform and Enterococci samples from December 16 were elevated (17,100 FC; >6000 Entero). The Operator stated nothing appeared out of the usual, and no alarms from the UV control panel were active. The ground fault circuit interrupters powering the US system were found to be tripped. Staff immediately restored the UV system and subsequent sample results were within range (8 FC; 25 Entero). E&I staff have implemented an additional alarm on the UV system through Telog that will alarm if any UV bank loses power. Staff were also provided additional training on verifying proper UV operation, sample collection, and hygiene techniques that will also be provided to operators on a refresher basis.

	Ammonia		
	CM	ON	UB
Dec 24		0.56	1.5
Jan 25	0.02	1.3	4.7
Feb 25		0.53	0.01
Mar 25		1.4	0.02
Apr 25	0.06	0.10	0.02
May 25		0.08	0.02
Jun 25		0.05	0.05
Jul 25	0.07	0.07	0.05
Aug 25		0.04	0.08
Sep 25		0.48	0.04
Oct 25	0.04	0.11	0.07
Nov 25		0.10	0.11
Dec 25		0.07	0.40

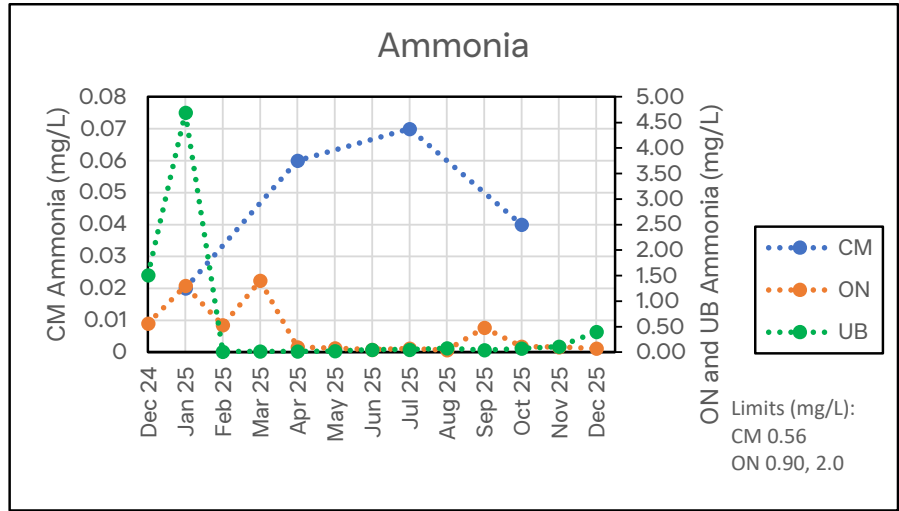

	TKN		
	CM	KW	SB
Dec 24		1.1	2.7
Jan 25	<0.50	1.1	0.80
Feb 25		0.99	0.60
Mar 25		2.1	0.80
Apr 25	0.75	1.3	1.0
May 25		1.2	0.60
Jun 25		1.0	0.80
Jul 25	0.92	0.97	3.0
Aug 25		0.98	0.70
Sep 25		1.0	0.70
Oct 25	0.95	1.3	1.3
Nov 25		1.0	1.6
Dec 25		1.0	1.2

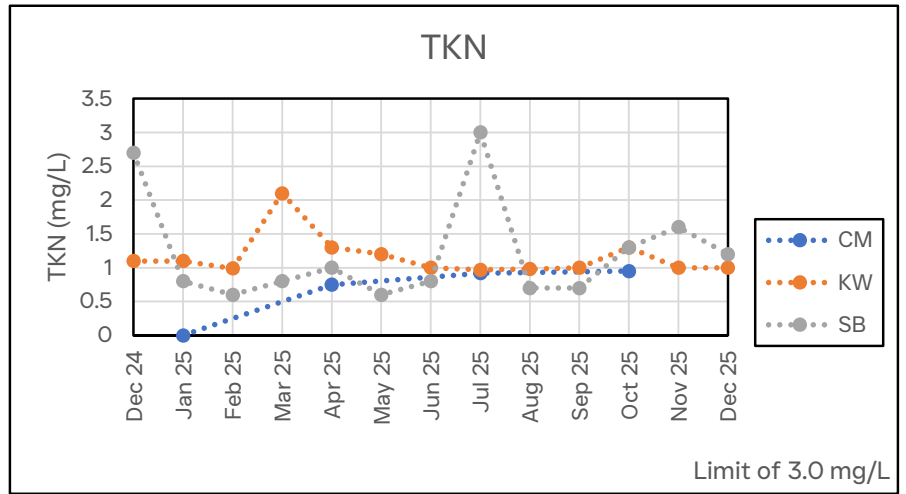

	Zinc	Copper
	KW	ON
Dec 24		
Jan 25	30	1.1
Feb 25		
Mar 25		
Apr 25	27	1.5
May 25		
Jun 25		
Jul 25		1.7
Aug 25	20	
Sep 25		
Oct 25	20	2.0
Nov 25		
Dec 25		

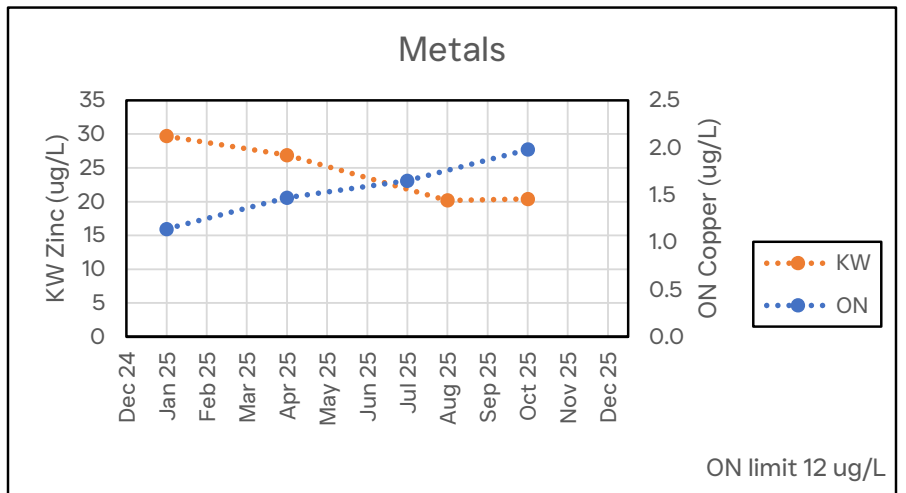

SC&H prepared the following Internal Audit Status document for the HRSD Commission. The status includes a summary of projects in process, upcoming projects, and management action plan updates.

I. Projects in Process

Grants Management

- **Completed Tasks (December 2025)**
 - Conducted internal audit kickoff meeting.
 - Review documentation provided by the HRSD team.
 - Conducted process understanding meetings.
 - Began creating flowcharts and RCM.
- **Upcoming Tasks (January 2026)**
 - Conduct additional process understanding meetings.
 - Continue review additional documentation received.
 - Continue drafting flowcharts and RCM.
 - Began drafting fieldwork audit program.

II. Upcoming Internal Audits

- Risk Assessment (January 2026)
- ProCards and Employee Expenses (February 2026)
- AI Governance and Operations (April 2026)

III. Management Action Plan Status

SC&H performs on-going management action plan (MAP) monitoring for completed internal audits/projects.

- SC&H begins MAP follow-up approximately one year following the completion of each audit and periodically follows up until conclusion.
- For each recommendation noted in an audit report, SC&H gains an understanding of the steps performed to address the action plan and obtains evidence to confirm implementation, when available.
- The following describes the current project monitoring status. This listing does not include audits which were determined by HRSD Management and the Commission to include confidential or sensitive information.



Audit / Project	Next Follow-up	Recommendations		
		Closed	Open	Total
Safety Division	January 2026	2	1	3
Personally Identifiable Information (PII)	January 2026	0	3	3
AP, ProCard	January 2026	1	2	3
CEL Assessment	March 2026	0	5	5
<i>Closed Audit/Projects (x22)</i>	Closed	136	0	136
	Totals	139	11	145

TO: Jill Morrison, Chief of Customer Care Center
FROM: SC&H Group, Inc.
DATE: November 24, 2025
SUBJECT: HRSD Arrears Payments, Current State Assessment: Summary of Results

I. Background

SC&H Group, Inc. (SC&H) was engaged by Hampton Roads Sanitation District (HRSD) to conduct a current state assessment of its arrears payment¹ function and operations, (collectively, assessment).

Arrears payment functions are centrally managed by HRSD's Customer Care Department, who serves as the primary point of contact for customers to pay and/or have questions about their bills, charges, and rates. The arrears payment function was included as part of the billing, accounts receivable, and aging process internal audit from the fiscal year 2025 (FY25) internal audit plan.

Transition: Internal Audit to Current State Assessment

During preliminary procedures, Customer Care informed SC&H of an impending major project, a migration from its on premises Oracle billing system to an Oracle Cloud billing system. Given this project, traditional audit procedures risked becoming obsolete.

To provide value without disrupting the project, SC&H and Customer Care agreed to conduct a current state assessment rather than a full internal audit. This approach evaluated existing operations, identified risks, and highlighted improvement opportunities tailored to HRSD's current environment.

SC&H maintained independence while collaborating with Customer Care to ensure recommendations were practical and transparent. Overall, Customer Care's engagement was instrumental in shaping actionable insights. While the results for a current state assessment do not require formal management action plans, Customer Care committed to addressing each finding.

The following provides the assessment's objectives, scope, and findings of the current state assessment.

II. Objectives

1. Evaluate the procedures for monitoring and complete data analytics on aging payments classifications to identify possible process improvements and/or recommendations, including:
 - a. Length of overdue payments (30, 60, 90, 180, 365+)
 - b. Collection efforts
 - c. Late fees, penalties, and deactivation
2. Evaluate write-offs and adjustments procedures to compare to applicable state regulations and best practices to identify possible process improvements and/or recommendations.
3. Evaluate the development of doubtful accounts estimates compared to best practices to identify possible process improvements and/or recommendations.

¹ A payment made after the work, service, or billing period is completed.

III. Scope

1. Customer Care Division: Customer Care within the Finance department manages and overages client accounts, billing, and payment receipt
2. Code of Virginia criteria: The assessment's scope included the following Code of Virginia criteria, which were incorporated into review procedures:
 - House Bill No. 919
 - House Bill No. 906 Chapter 824

IV. Approach

Research and Documentation Review

SC&H conducted external research to review the Code of Virginia standards for guidance on organizational requirements and abilities to seek payment from customers who are in a delinquent status. Following research, SC&H reviewed Customer Care and organizational documentation to understand the current processes in place for seeking payment on delinquent accounts, including:

1. Debt Solutions Process Flow
2. 2023 Collections Process
3. Current state data on delinquent accounts from 1/1/2025 to 6/30/2025

Interviews

SC&H conducted process understanding interviews with Customer Care to understand the current practices for seeking payment on delinquent.

Evaluation & Data Analytics

Following documentation reviews and interview, SC&H performed data analytical procedures to determine the following information on the current state of delinquent accounts including current value of the delinquent account in the timeline of HRSD's collection process including:

1. Current, 0-30 Days, 31-60 Days, 61-90 Days, 91-180 Days, 181-365 Days, Over 365, and Total.
2. Accounts with the highest values of delinquent amounts.
3. Total values of accounts in the timeline for the localities that HRSD serves.

Results and Recommendations

Commendations

Customer Care continues to demonstrate HRSD's commitment to efficient, effective, and transparent operations led by dedicated individuals. The assessment identified a structured method and process for identifying, monitoring, and seeking reimbursement for client accounts that are delinquent in payment for services provided. This approach ultimately provides HRSD's leadership with organizational insights, enabling them to take informed actions and resolve issues effectively.

Summary Findings

The following summarized findings and recommendations offer Customer Care and HRSD with opportunities to improve its arrears function and mitigate future risks and payment challenges. Detailed information has been provided to Customer Care in supplemental documentation to help support addressing challenges.

1. **Data Monitoring and Visualization:** Current tracking mechanisms offer a partial perspective of the current state of delinquent accounts. This limits the HRSD's ability to

identify trends in collectibles, assess performance, and make informed decisions with confidence.

Summary Recommendation: Implement tracking mechanisms to monitor and report on following arrears payment categories (e.g., month-to-month trend, segmented data by city and municipality, additional trends, etc.).

2. **Data Collection and Visualization:** The collections process involves a variety of outreach methods including door hangers, text messages, and mailed notices. However, the effectiveness of each of these efforts individually is not systematically tracked or attributed to repayment outcomes.

Summary Recommendation: Implement outreach attribution tracking tactics and metrics. Following, use the results to determine which communication methods are most effective in receiving delinquent payment.

3. **Funding Allocation:** HRSD currently receives voluntary donations to assist in paying customer account balances that are applied directly to delinquent customer accounts to help with recovery. The allocation of funds is determined by the Hampton Roads Planning District Commission (HRPDC) and is based on the population of each locality. This allocation process may result in some communities being allocated money that is disproportionate to the financial need. Once funds are allocated, credits are applied to an account holder's balance is based on financial need. Eligibility for each account holder is determined by the Salvation Army.

Summary Recommendation: Consider working with the HRPDC to implement a targeted allocation strategy that allocates funding for communities based on the greatest need (i.e., allocating funds based on poverty levels). This could help improve recovery efforts and reduce uncollectible fees.

4. **Debt-Set-Off Utilization:** Currently, Debt Set-Off (DSO) is applied on an all-or-nothing basis, which limits how it is used.

Summary Recommendations:

Refine and monitor the threshold for DSO by establishing transparent, consistent criteria. For instance, define a minimum dollar amount accrued by a specific day (e.g., \$100 by day 60) to standardize usage and enhance collections performance. This approach promotes fairness and predictability in applying the collection tool, reinforcing trust and accountability in the process.

Strategic Measures
December 2025

Strategic Planning Measure	Nov-2025	Dec-2025	FY-26
Educational and Outreach Events	3	7	75
Number of Community Partners	8	10	87
Number of Technical Presentations	6	4	20
Number of Technical Publications	0	1	454
Revenue vs. Budget	43%	51%	51%
Wastewater Expenses vs. Budget	35%	41%	41%
Accounts Receivable (HRSD)	\$62,057,081	\$54,260,891	\$56,335,652
Aging Accounts Receivable	27.40%	32.30%	31.72%
Turnover Rate wo Retirements	0.44%	0.33%	2.32%
Turnover Rate w Retirements	0.55%	1.31%	4.07%
Avg Time to Hire (Posting to Acceptance)	3 months 24 days	3 months 30 days	3 months 10 days
Number of Vacancies	71	72	71
Average number of applicants per position	6.3	4.0	5.7
Percentage of positions filled with internal applicants	44.0%	22.2%	28.8%
Recruitment source Return on Investment	*	*	*
Avg Time to Hire (Acceptance to NEO)	25.16	15.00	*
Customer Call Wait Time (mins)	5.46	8.32	6.22
Capacity Related Overflows with Stipulated Penalties (Reported Quarterly)	*	*	*
Non-Capacity Related Overflows with Stipulated Penalties (Reported Quarterly)	*	*	*
TONS OF CARBON: Tons of carbon produced per million gallons of wastewater treated Energy consumed (gas (scfm) and electricity (kWh)) per million gallons of wastewater treated.	N/A	N/A	0
GAS CONSUMPTION: Tons of carbon produced per million gallons of wastewater treated Energy consumed (gas (scfm) and electricity (kWh)) per million gallons of wastewater treated.	N/A	N/A	*
ELECTRICITY CONSUMPTION: Tons of carbon produced per million gallons of wastewater treated Energy consumed (gas (scfm) and electricity (kWh)) per million gallons of wastewater treated.	N/A	N/A	0
Cumulative CIP Spend	\$306,573,798		\$457,900,000

*Not currently tracking due to constraints collecting the data.

** Updated after EPA Quarterly Report submittal.

***Billing is one month behind



Strategic Measures

December 2025

Community Partners

Date	Division	Event
12/01/2025	Operations	New Kent County
12/02/2025	Operations	Accomack County
12/03/2025	Engineering	Hampton University
12/04/2025	Communications	Tidewater Community College
12/04/2025	Communications	HRSD employees
12/08/2025	Communications	Youth Volunteer Corps of Hampton Roads
12/10/2025	Communications	Cape Henry Collegiate School
12/10/2025	Engineering	ForKids
12/10/2025	Engineering	Cape Henry Collegiate School
12/10/2025	Communications	ForKids
12/11/2025	Engineering	VNCEA Annual Meeting and Board Meeting
12/18/2025	Operations	the Virginia Beach Technical and Career Education Center

Educational Outreach

Date	Division	Event	Community Partner
12/3/2025	Engineering	Virtually supported Hampton University undergraduate students working on a senior project	Hampton University
12/4/2025	Communications	SWIFT RC Tour - HRSD Employees, friends and family	HRSD
12/4/2025	Communications	SWIFT RC Tour - TCC Geology Class	Tidewater Community College
12/8/2025	Communications	Classroom activity outreach development with Youth Volunteer Corps Hampton Roads	Youth Volunteer Corps Hampton Roads
12/10/2025	Engineering	Washing Water activity - ForKids (middle school students)	ForKids
12/10/2025	Communications	SWIFT RC Tour - Cape Henry Collegiate Social Entrepreneurship Cohort	Cape Henry Collegiate
12/10/2025	Communications	Washing Water activity - ForKids (middle school students)	ForKids
12/10/2025	Engineering	SWIFT RC Tour - Cape Henry Collegiate Social Entrepreneurship Cohort	Cape Henry Collegiate
12/15/2025	Engineering	Larchmont Civic League Meeting	Larchmont Civic League

Strategic Measures

December 2025

Technical Presentations

Date	Division	Presentation	Presenter
12/3/2025	Operations	"PhD Defense: Low dissolved oxygen nitrogen removal: Pilot-scale evaluation and in-situ estimation of nitrifier kinetics adaptation"	Kester McCoullough
12/5/2025	Operations	"Wastewater Treatment and Fundamentals - Data Center Discharges"	Charles Bott
12/10/2025	Operations	"Standing Up HRSD's Digital Water Department"	Jeff Sparks
12/10/2025	Operations	"Intensifying, Optimizing, and Innovating: Wastewater Design and Operation @ HRSD w/ WWW"	Charles Bott

Technical Publications

Date	Division	Publication Title	HRSD Author(s)	Location
12/2/2025	Water Quality	PFAS retention and distribution in the vadose zone of three soil types impacted by biosolids application	Chris Burbage, Kenny Hoffman, and April Richardson	Journal of Environmental Management. Vol. 396. Article # 128137